

Leda

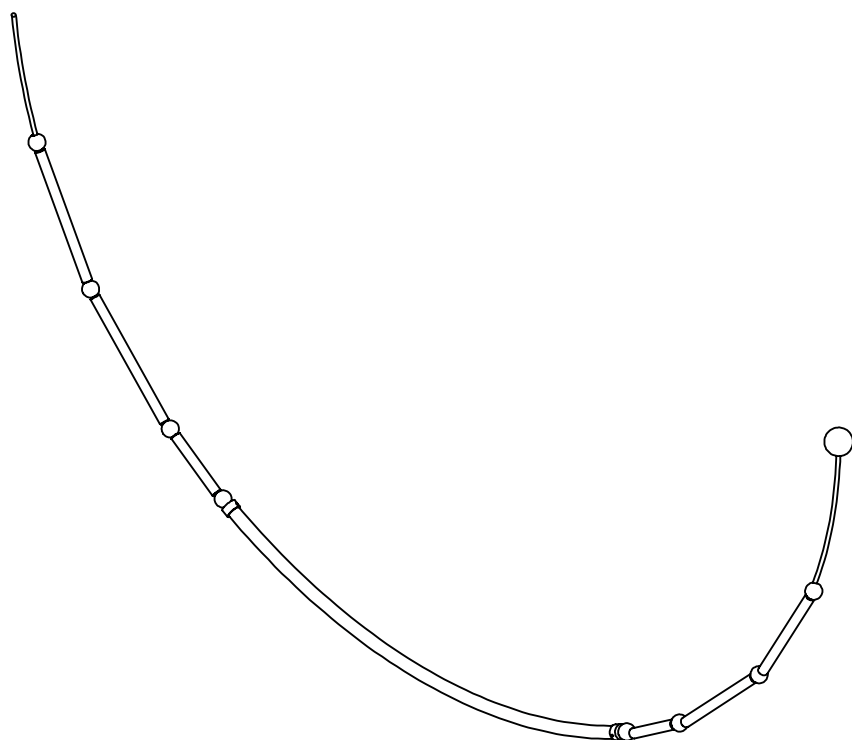

KARMAN

SE293 N1 EXT
SE293 O1 EXT

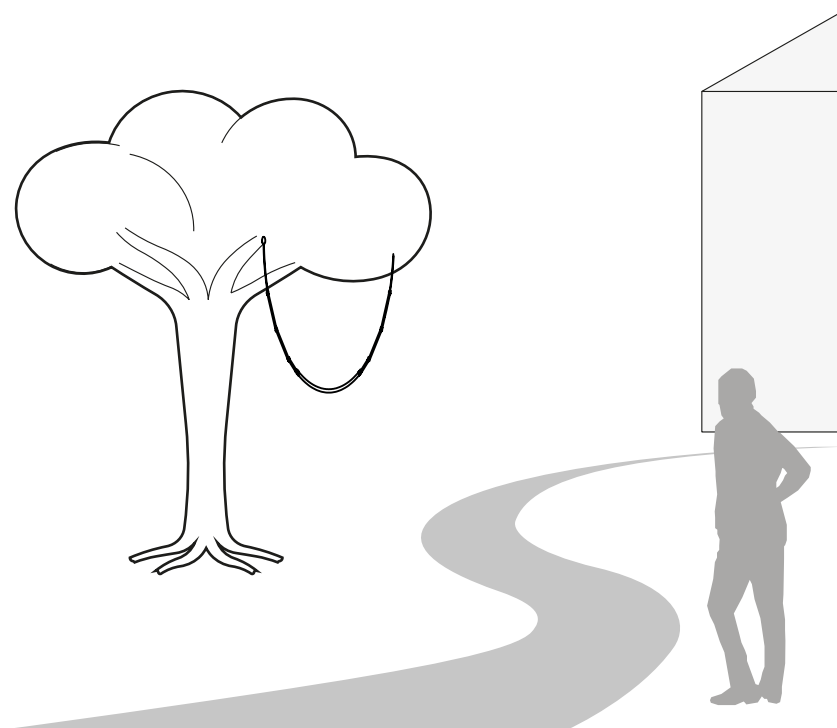

Karman srl

Via A. Grandi, San Martino del piano, 61034 Fossombrone (PU), Italy
p.iva 02175640412 tel +39 0721 71 5042 r.a fax +39 0721 716640 - www.karmanitalia.it

apparecchio fornito di sorgente luminosa di classe energetica G
lamp equipped with light source energy class G

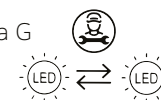

LED 24V 14,4W
3000 K°

IP65



C - 01

F

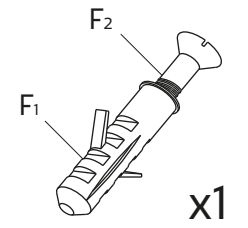

C

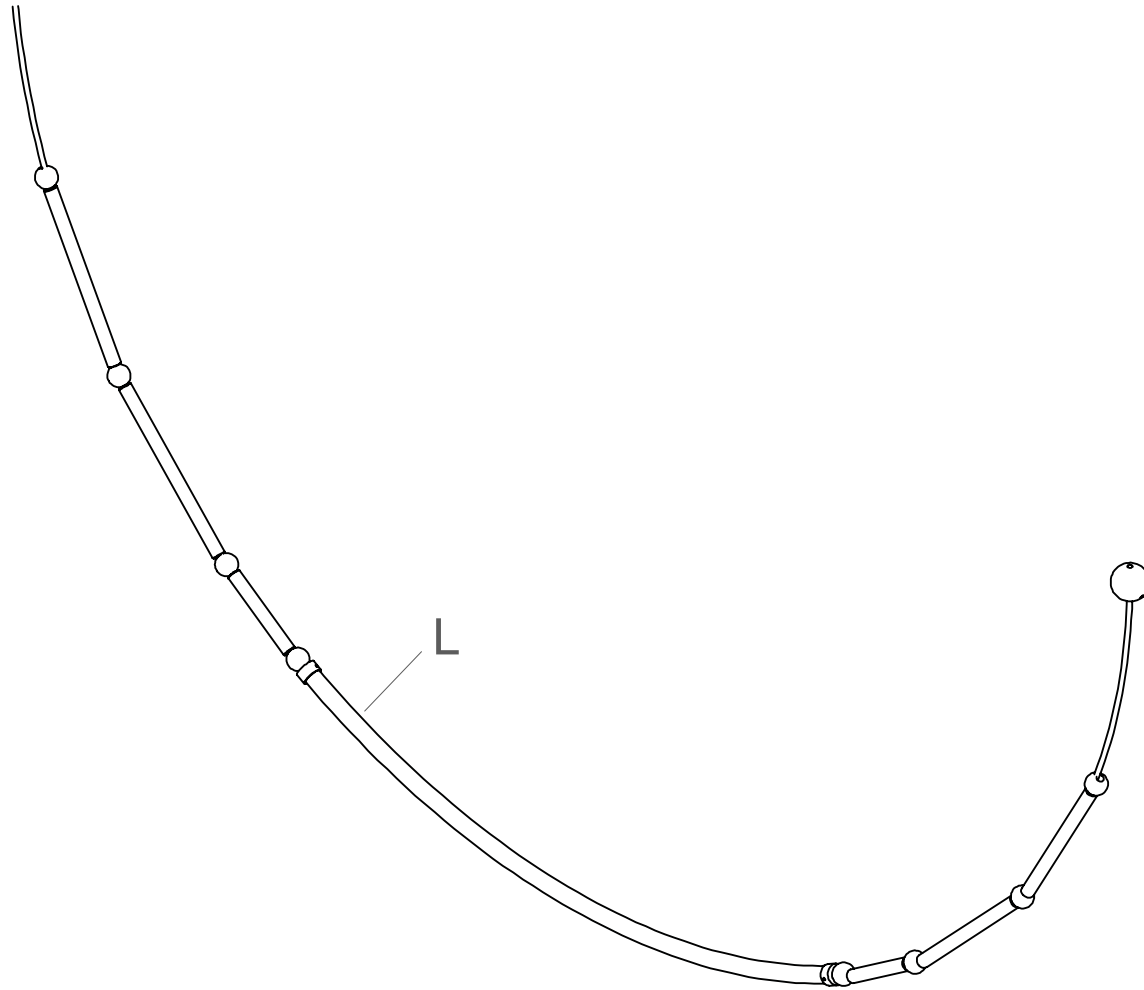
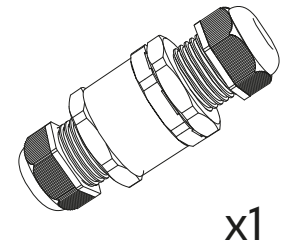

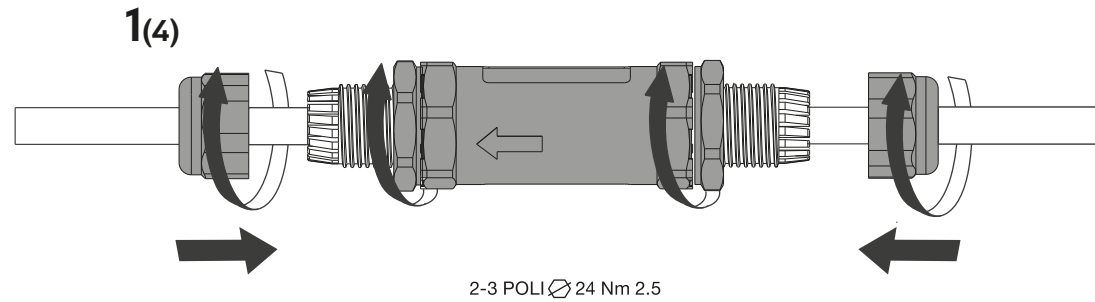
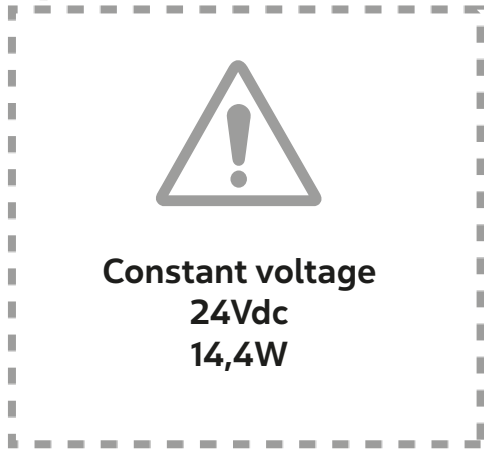
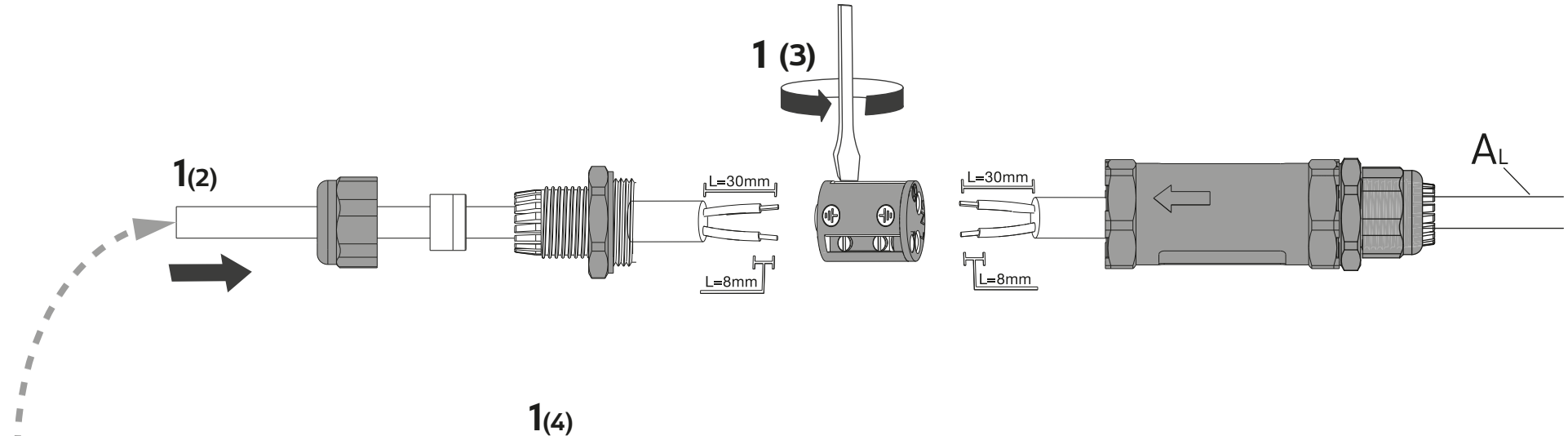
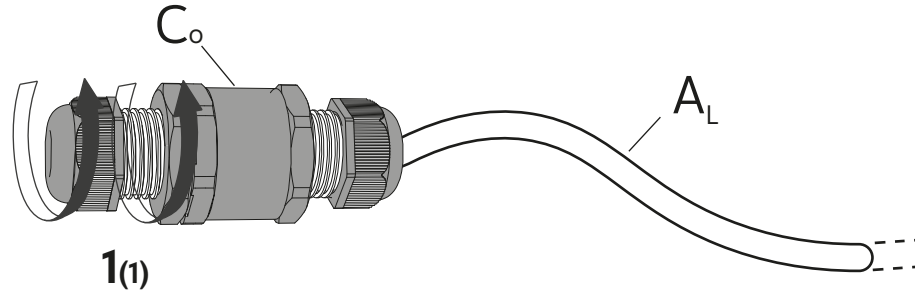
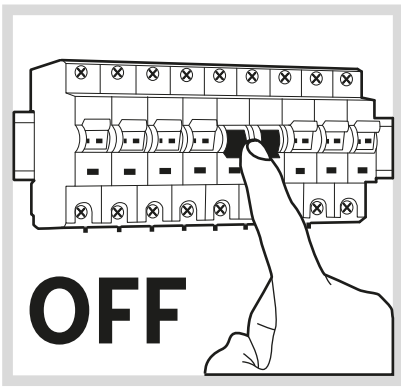

2

