

Filomena

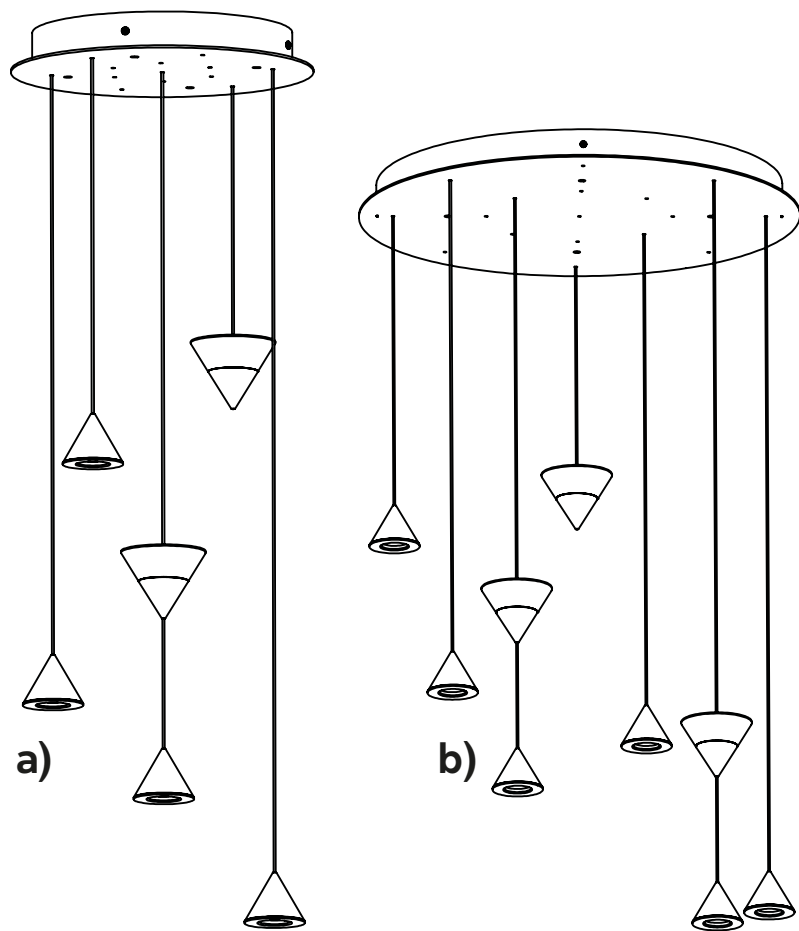

- a) SE270 AN V11
- a) SE270 BN V11
- b) SE270 CN V11
- b) SE270 DN V11

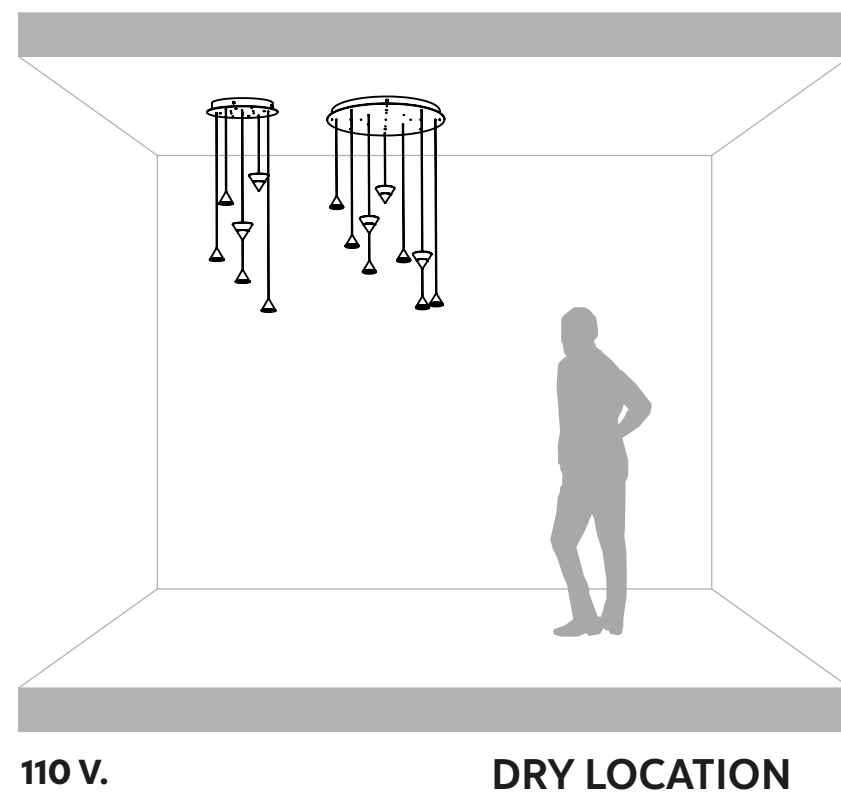

IT _Se il cavo flessibile esterno di quest'apparecchio viene danneggiato, deve essere sostituito dal costruttore o dal servizio di assistenza o da personale qualificato equivalente al fine di evitare pericoli.
-Togliere tensione prima dell'installazione o di qualsiasi manutenzione.
-Il prodotto deve essere montato da personale qualificato, rispettando le norme impianti in vigore.

 <p>0-14</p>	Attenzione! Apparecchio artistico, tenere lontano dalla portata dei bambini.		Attenzione! Rischio scossa elettrica. Togliere la tensione elettrica in assenza di lampadina.
--	--	---	---

EN _If the flexi cord on the outside of this appliance becomes damaged, it must be replaced by the manufacturer or by its assistance service or a qualified service engineer, in order to avoid all hazard risks.
-Disconnect from the mains power before installing or carrying out any maintenance.
-This item must be fitted by a qualified person, compliant with current installation regulations.

 <p>0-14</p>	Warning! Artistic appliance. Keep out of the reach of children.		Warning! Electric shock risk. Disconnect from the mains power if no light bulb is fitted.
--	---	---	---

FR _Si le câble souple externe de cet appareil est endommagé, il doit être remplacé par le fabricant, par son service d'assistance ou par une personne qualifiée afin d'éviter tout danger.
-Couper l'alimentation avant l'installation ou toute opération d'entretien.
-Le produit doit être installé par un personnel qualifié, en respectant les règles d'installation en vigueur.

 <p>0-14</p>	Attention ! Cet appareil n'est pas un jouet, tenir hors de la portée des enfants.		Attention ! Risque de choc électrique. Couper l'alimentation électrique en l'absence d'ampoule.
--	---	---	---

DE _Wenn das äußere Kabel dieses Gerätes beschädigt wird, muss es durch den Hersteller, den Kundendienst oder ähnlich qualifizierte Personen ersetzt werden, um Gefahren zu vermeiden.
-Unterbrechen Sie die Stromversorgung vor der Installation oder Wartung.
-Das Produkt darf nur von qualifizierten Personen und unter Beachtung der geltenden Anlagenvorschriften installiert werden.

 <p>0-14</p>	Achtung! Kein Spielzeug! Bitte von Kindern fernhalten.		Achtung! Stromschlaggefahr. Unterbrechen Sie die Stromversorgung, falls keine Glühbirne eingeschraubt ist.
--	--	---	--

ES _Si el cable flexible externo de este aparato se daña debe ser sustituido por el fabricante o el servicio de asistencia o personal cualificado equivalente para evitar peligros.
-Quitar tensión antes de proceder con la instalación o cualquier trabajo de mantenimiento.
-El producto debe ser montado por personal cualificado de conformidad con las normas vigentes para instalaciones.

 <p>0-14</p>	¡Atención! Aparato artístico, mantener alejado del alcance de los niños.		¡Atención! Riesgo de choque eléctrico. Desconectar la tensión eléctrica en ausencia de bombilla.
--	--	---	--

PT _Se o cabo flexível externo deste aparelho for danificado, deve ser substituído pelo fabricante ou pelo serviço de assistência ou por pessoal qualificado equivalente, para evitar perigos.
-Desligue a tensão antes da instalação ou qualquer operação de manutenção.
-O produto deve ser montado por pessoal qualificado, respeitando as normas dos sistemas em vigor.

 <p>0-14</p>	Atenção! Aparelho artístico, manter longe do alcance das crianças.		Atenção! Risco de choque elétrico. Desligar a tensão elétrica na ausência de lâmpada.
--	--	---	---

NL _Om gevaar te vermijden moet de externe flexibele kabel van dit apparaat, indien beschadigd, door de fabrikant, zijn technische dienst of equivalent bevoegd personeel vervangen worden.
-Voor elke installatie of onderhoudswerkzaamheid de spanning afsluiten.
-Het product moet door bevoegd personeel gemonteerd worden met inachtname van de geldende normen.

 <p>0-14</p>	Aandacht! Art apparaatuur, uit de buurt van kinderen houden.		Aandacht! Gevaar voor elektrische schokken. Als geen lamp aanwezig is de stroom afsluiten.
--	--	---	--

SV _Om apparatens sladd skadras ska de för att förhindra risker bytas ut av tillverkaren, kundservice eller likvärdig kvalificerad personal.
-Koppla alltid bort spänningen innan installation eller underhållsarbete.
-Produkten ska monteras av kvalificerad personal som ska följa gällande anläggningsföreskrifter.

 <p>0-14</p>	Observeral Detta är ett konstföremål, inte en lek sak, och ska förvaras utom räckhåll för barn.		Observeral Risk för elstöt. Koppla bort den elektriska spänningen när det saknas lampa.
--	---	---	---

NO _Hvis den bøyelige ytre ledningen ved dette apparatet skades, må den skiftes ut av produsenten eller servicetjenesten eller av tilsvarende kvalifiserte fagfolk for å kunne unngå farer.
-Koble fra spenningen før installasjon eller ethvert vedlikeholdsingrep.

-Produktet må være montert av kvalifisert fagfolk, mens de gjeldene lovfor skriftene overholdes.

 <p>0-14</p>	Advarsell Kunstnerisk apparat, må holdes utenfor barns rekkevidde.		Advarsell! Fare for elektrisk stot. Koble fra den elektriske spenningen hvis lypaeren mangler.
--	--	--	--

FI _Jos tämän laitteen ulkopuolinen johto vahingoittuu, vaarojen välttämiseksi se on annettava vaihdettavaksi valmistajalle tai huoltopalvelulle tai vastaavaan ammattitaitoinen omaavalle henkilökunnalle.
-Poista jännite ennen asennusta tai ennen minkä tahansa huoltotoimenpiteen suorittamista.
-Tuote on asennettava ammattitaitoisen henkilökunnan toimesta voimassa olevia määräyksiä noudattaen.

 <p>0-14</p>	Varoitus! Taidelaite, pidä lasten ulottumattomissa.		Varoitus! Sähköiskuvaara. Poista sähköjännite, kun laitteessa ei ole lampua.
---	---	---	--



PL _Jeżeli przewód giętki na zewnątrz urządzenia zostanie uszkodzony, ze względów bezpieczeństwa musi zostać wymieniony przez producenta, serwis techniczny lub osobę o równorzędnych kwalifikacjach.
-Przed przystąpieniem do instalacji lub jakiegokolwiek czynności konserwacyjnej odłączyć napięcie.
-Produkt musi zostać zamontowany przez wykwalifikowany personel zgodnie z obowiązującymi przepisami dotyczącymi instalacji.

 <p>0-14</p>	Uwaga! Wyrób artystyczny, przechowywać poza zasięgiem dzieci.		Uwaga! Niebezpieczeństwo porażenia prądem. W przypadku braku żarówki odłączyć od napięcia elektryczny.
---	---	---	--



CS _V případě poškození externího kabelu tohoto světidla musíte zajistit jeho výměnu prostřednictvím výrobce, technického servisu nebo kvalifikovaného technika, aby nedošlo k žádným nebezpečným situacím.
-Před instalací udrzte odpojte od přívodu elektrického proudu.
-Výrobek musí namontovat kvalifikovaný technik za dodržení platných předpisů.

 <p>0-14</p>	Pozor! Umělecké světídlo. Uchovávejte mimo dosah dětí.		Pozor! Nebezpečí zásahu elektrickým proudem. Po sejmutí žárovky odpojte světídlo od přívodu elektrického proudu.
---	--	---	--



SK _Ak sa poškodí externý flexibilný kábel tohto svetidla, výrobca alebo asistenčná služba alebo kvalifikovaný pracovník musí vykonať jeho výmenu za rovnaký, aby sa predišlo rizikám.
-Pred vykonaním inštalácie alebo akejkoľvek údržby odpojte napätie.
-Výrobok musí namontovať kvalifikovaný pracovník s dodržaním platných noriem.

 <p>0-14</p>	Upozornenie! melecké svetídlo. Uchovávejte mimo dosahu detí.		Upozornenie! Riziko zasiahnutia elektrickým prúdom. Ak sa v prístroji nachádza žiarovka, vypnite elektrický prúd.
---	--	---	---



SL _Če se zunanji prožni kabel naprave poškoduje, ga mora zamenjati proizvajalec ali serviser ali enakovredno usposobljeno oseboje in tako preprečiti nevarnost.
-Pred namestitvijo ali kakršnim koli vzdrževanjem izklopite napajanje.
-Proizvod mora namestiti strokovno usposobljena oseba ob upoštevanju veljavnih predpisov za nameštitev.

 <p>0-14</p>	Pozor! Umetnički izdelek hranite izven dosega otrok.		Pozor! Nevarnost električnega udara. Izklopite napajanje, če žarnica ni vstavljenja.
---	--	---	--

BG _Ако външният гъвкав кабел на това осветително тяло бъде повреден, той трябва да се подмени от производителя, от центъра за обслужване на клиенти или от друг квалифициран персонал, за да се избегнат евентуални рискове.
-Изключете захранването преди да извършвате операции по монтаж или поддръжка.
-Продуктът трябва да се монтира от квалифициран персонал при спазване на съответните действащи правила и разпоредби.

 <p>0-14</p>	Внимание! Декоративно осветително тяло. Да се пази далече от достъп на деца.		Внимание! Риск от токов удар. Изключете захранването от липса на електрическа крушка.
---	--	---	---

RO _În situația în care cablul flexibil exterior al acestui aparat este deteriorat, este necesar să fie înlocuit de producător sau de serviciul de asistență ori de personal calificat echivalent, pentru preîntâmpinarea pericolului.
-Întreprueți alimentarea cu tensiune mai înainte de instalare sau de orice operațiune de întreținere.
-Produsul trebuie să fie montat de personal calificat, conform standardelor în vigoare privind instalațiile.

 <p>0-14</p>	Atenție! Aparat artistic, nu lăsați la îndemâna copiilor.		Atenție! Risc de electrocutare. Întrerupeți alimentarea cu tensiune electrică în lipsa becului.
---	---	---	---

HR _Ako se vanjski savitljivi kabel ovog uređaja ošteti, proizvođač ili servisna služba ili odgovarajuće osposobljeno osoblje moraju ga zamijeniti kako se ne biste izlagali mogućim opasnostima.
-Isključite napajanje prije postavljanja ili izvođenja bilo kojeg postupka održavanja.
-Postupak postavljanja treba obaviti osposobljeno osoblje i pritom se pridržavati važećih pripadajućih pravila.

 <p>0-14</p>	Pažnja! Budući da je riječ o zanimljivom uređaju, držite ga izvan dosega djece.		Pažnja! Rizik od strujnog udara. Isključite napajanje ako nema žarulje.
--	---	--	---

SQ _Nëse kablloja fleksibël e jashtme e kësaj pajisje dëmtohet, për të shmangur rreziqtë, ajo duhet të zëvendësohet nga konstruktori, shërbimi i asistencës ose nga personeli i kualifikuar ekuivalent.
-Heqim tensionin para instalimit ose para çdo lloji rimbërmbaje.
-Produkti duhet të montohet nga një personel i kualifikuar, duke respektuar normat në fuqi për impiantet.

 <p>0-14</p>	KUJDESI! Pajisje artistike, duhet mbajtur larg nga vendet që arrihen nga fëmijët.		KUJDESI! Rezik goditje elektrike. Kur llamba nuk është e montuar, duhet të shkëputim furnizimin me energji elektrike.
---	---	---	---

SR _Ako se spoljni kabl ovog uređaja ošteti, isti mora biti zamenjen od strane proizvođača, ovlašćenog servisa ili kvalifikovanog osoblja kako bi se izbegle moguće opasnosti.
-Pre ugradnje ili bilo kakvog održavanja, isključiti struju.
-Proizvod mora biti montiran od strane kvalifikovanog osoblja, u skladu sa važećim propisima.

 <p>0-14</p>	Pažnja! Umetnički komad. Držite ga dalje od dohvata dece.		Pažnja! Rizik od strujnog udara. Isključiti iz struje kada u uređaju nema sijalice.
---	---	---	---

TR _Bu cihazın dış esnek kablusunun hasar görmesi halinde, tehniklerin önlenmesi amacıyla, işbu kablo imalatçı veya teknik servis ya da eşdeğer kalifiye personel tarafından değiştirilmelidir.
-Kurulumdan veya herhangi bir bakım işleminden önce gerilimi kesiniz.
-Ürün, yürürlükteki yönetmeliklere uygun olarak, kalifiye personel tarafından monte edilmelidir.

 <p>0-14</p>	Dikkat! Dekoratif cihaz, çocukların ulaşamayacağı yerlerde saklayınız.		Dikkat! Elektrik çarpması riski. Ampul yoksa elektrik gerilimini kesiniz.
---	--	---	---



SH _Ako je oštećen vanjski savitljivi kabl ovog uređaja mora biti zamijenjen od strane proizvođača ili odgovarajućeg servisnog centra ili kvalifikovanog osoblja kako bi se izbjegla opasnost.
-Isključite napajanje prije instalacije ili bilo kakvog održavanja.
-Proizvod mora biti montiran od strane kvalifikovanog osoblja, u skladu sa važećim propisima.

 <p>0-14</p>	Upozorenje! Umjetnički uređaj, držati podalje od djece.		Upozorenje! Rizik od strujnog udara. Isključite napajanje strujom u odsustvu sijalice.
---	---	---	--

EL _Εάν το εξωτερικό εύκαμπτο καλώδιο αυτής της συσκευής έχει υποστεί ζημιά, θα πρέπει να αντικατασταθεί από τον κατασκευαστή ή το σέρβις ή από προσοιτούχο προσωπικό, προκειμένου να αποφευχθεί τυχόν κίνδυνος.
-Απαιρείται την τάση πριν από την εγκατάσταση ή από οποιαδήποτε συντήρηση.
-Το προϊόν πρέπει να εγκατασταθεί από εξειδικευμένο προσωπικό, σύμφωνα με τους κανονισμούς εγκατάστασης.

 <p>0-14</p>	Προσοχή! Καλλιεχνική συσκευή, να φυλάσσεται μακριά από παιδιά.		Προσοχή! Ένεχει κίνδυνο ηλεκτροπληξίας. Αποσυνδέστε την παροχή ηλεκτρικού ρεύματος σε περίπτωση σπασίας του λαμπτήρα.
---	--	---	---



RU _Если у данного прибора окажется поврежденным наружный шнур, то, во избежание риска, обратитесь за его заменой к изготовителю, либо в сервисный центр, либо к обладателю необходимого квалификации мастеру.
-Перед осуществлением монтажа и любого технического обслуживания отключайте напряжение.
-Установка прибора должна осуществляться квалифицированными мастерами в соответствии с действующими правилами электромонтажа.

 <p>0-14</p>	Внимание! Данное художественное изделие необходимо хранить в недоступном для детей месте.		Внимание! Риск поражения электрическим током. При отсутствии лампычик отключайте электронапряжение.
---	---	---	---

UK _Якщо зовнішній гнучкий кабель чи шнур світильника пошкоджено, його має замінити виробник чи представник служби обслуговування або особа з відповідною кваліфікацією, щоб уникнути небезпек.
-Перш ніж встановлювати виріб або проводити будь-які дії з технічного обслуговування, слід від'єднати світильник від джерела живлення.
-Виріб має встановлюватися кваліфікованим спеціалістом відповідно до діючих стандартів.

 <p>0-14</p>	Увага! Художній виріб. Тримати подаль від дітей.		Увага! Небезпека ураження електричним струмом. Від'єднати світильник від джерела живлення якщо електрична лампочка відсутня.
---	--	---	--

LV _Ja šai ierīcei ir bojāts ārējais lokālais vads, tā nomaina jāuztiek ražotājam, servisa centra speciālistam vai darbiniekam ar līdzīgu kvalifikāciju, lai izvairītos no briesmām.
-Pirms uzstādīšanas vai iebūvēšanas darbu veikšanas atslēdziet strāvas padevi.
-Produkta uzstādīšana jāuztiek kvalificētam speciālistam, kuram jāievēro spēkā esošie noteikumi elektroinstalācijas darbu jomā.

 <p>0-14</p>	Uzmanību! Mākslas izstrādājums, turēt bērniem neaizsniēdzamā vietā.		Uzmanību! Elektriskās strāvas trieciena risks. Atslēdziet strāvas padevi, ja nav uzstādīta spuldze.
---	---	---	---

LT _Jei išorinis lankstus šio prietaiso laidas yra pažeistas, jį turi pakeisti gamintojas, techninės priežiūros paslaugų teikėjai arba atitinkami kvalifikuoti darbuotojai, kad būtų išvengta pavojų.
-Prieš įrengimą ar bet kokią techninę priežiūrą išjunkite šaltinį.
-Gaminį turi įrengti kvalifikuoti darbuotojai, laikydamiesi galiojančių įrenginių įrengimo taisyklių.

 <p>0-14</p>	Atsargiai! Tai meninis įrenginys, saugoti nuo vaikų.		Atsargiai! Elektros smūgio pavojus. Nesant lemputės, išjunkite srovės šaltinį.
---	--	---	--



ET _Kui seadme väline painduv juhe saab kahjustada, peab selle ohtude vältimiseks välja vahetama kas toote valmistaja, teeninduskeskuse või samasuguse kvalifikatsiooniga töötaja.
-Paigaldamisel või enne mis hoolduse tegemist eemaldage seade elektrivõrgust.
-Toote tohult paigaldada ainult asjakohaste kutseoskustega töötaja, kes järgib seadmetele kehtivaid ettekirjutusi.

 <p>0-14</p>	Tähelepanu! See on kunstine seade, mitte mänguasi. Hoida lastele kättesaamatus kohas.		Tähelepanu! Elektrilöögi oht. Kui elektrilamp ei ole paigaldatud, siis ärge seadete elektrivõrku ühendage.
---	---	---	--



ZH _若本设备的对外接柔性电线受损，必须由制造商、售后服务方或具有相同资质的专业人员更换，以避免发生事故。
安装或维修前切断电源。
本设备需由专业人士遵照相关规定进行安装。

 <p>0-14</p>	请注意！本设备为工艺品，请放在远离儿童的地方。		请注意！小心触电。无灯时请务必切断电源。
---	-------------------------	---	----------------------

KO _본 기기의 외부 전선 케이블이 손상된 경우, 위험을 방지하기 위해 제조사 또는 서비스 센터 또는 이와 동등한 자격을 갖춘 전문가에 의해 교체해야 합니다. 어떠한 경우라도 기기를 보수하거나 설치 시에는 전원을 차단해야 합니다. 이 제품을 준비가 된 자격을 갖춘 전문가에 의해 설치 규정을 준수하여 설치되어야 합니다.

 <p>0-14</p>	주의! 디자인 기가라 어린이의 주의를 끌기 쉬운, 어린이의 손이 닿지 않는 곳에 보관하십시오.		주의! 감전 위험이 있습니다. 기기에 전기가 설치되지 않은 상태에서는 전원을 차단하십시오.
---	--	---	--



JA _外部ケーブルが損傷した場合の交換は、危険を避けるため、生産者かアフターサービス、または同等の資格者が行ってください。取り替えを含むあらゆるメンテナンスをする際は、必ず電源をお切りください。
組み立ての際は取扱説明書に従い、有資格者が行ってください。

 <p>0-14</p>	注意！デザイン器具ですので、お子様の手の届かないところでご使用ください。		注意！感電の恐れがあります。電球を取り外した際は、電源をお切りください。
---	--------------------------------------	---	--------------------------------------



HI _खतर से बचने के लिए उपकरण का क्षतिग्रस्त बाहरी लचीला तार निम्नाना या बिक्री के उपरान्त सर्विस कर्मचारियों द्वारा ही बदला जाना चाहिए। तार बदलने के पहले या रखरखाव के किसी भी कार्य से पहले बिजली बंद कर दें। प्रोडक्ट योग्य कर्मचारियों द्वारा ही नियमानुसार तरीकेसे इन्स्टॉल किया जाना चाहिए ।

 <p>0-14</p>	सावधान! उपकरण कालमात्रक है अतः बच्चों से दूर रखें।		सावधान! बिजली के झटके का खतरा है। बल्ब न होने पर बिजली की आपूर्ति काट दें।
---	--	---	--



HE _התקנת המוצר תבוצע על ידי אנשים מוסמכים בלבד, בהתאם לתקנות ההורגות בנושא מתקנים. אזהרה! סכנת התחשמלות. אזהרה! מכשיר חשמלי. אמונתו, יש להרחיק מהישג ידם של ילדים. את אספקת החשמל.

 <p>0-14</p>	אזהרה! מכשיר חשמלי. אמונתו, יש להרחיק מהישג ידם של ילדים. את אספקת החשמל.		אזהרה! סכנת התחשמלות. אזהרה! מכשיר חשמלי. אמונתו, יש להרחיק מהישג ידם של ילדים. את אספקת החשמל.
---	---	---	---

AR _إذا تعرض السلك الخارجي المرن للجهاز إلى التلف فيجب استبداله من قبل الشركة المصنعة أو مركز خدمة المساء عدة أو من قبل عمال مؤهلين من نوي الخبرة، وذلك تجنباً للتعرض إلى المخاطر. يجب فصل المنتج عن التيار الكهربائي عند التركيب وعند القيام بآية عملية من عمليات الصيانة.
-يجب أن يقوم عمال مؤهلين بتركيب المنتج ويجب أن يتم هذا بالاستناد إلى التوجيهات السارية الخاصة بالأجهزة.

 <p>0-14</p>	تنبيه! خطر الإصابة بالصعق الكهربائي. يجب فصل الجهاز عن التيار الكهربائي عند عدم وجود الصمام الكهربائي.		تنبيه! خطر الإصابة بالصعق الكهربائي. يجب فصل الجهاز عن التيار الكهربائي عند عدم وجود الصمام الكهربائي.
---	--	---	--

LV _Ja šai ierīcei ir bojāts ārējais lokālais vads, tā nomaina jāuztiek ražotājam, servisa centra speciālistam vai darbiniekam ar līdzīgu kvalifikāciju, lai izvairītos no briesmām.
-Pirms uzstādīšanas vai iebūvēšanas darbu veikšanas atslēdziet strāvas padevi.
-Produkta uzstādīšana jāuztiek kvalificētam speciālistam, kuram jāievēro spēkā esošie noteikumi elektroinstalācijas darbu jomā.

 <p>0-14</p>	Uzmanību! Mākslas izstrādājums, turēt bērniem neaizsniēdzamā vietā.		Uzmanību! Elektriskās strāvas trieciena risks. Atslēdziet strāvas padevi, ja nav uzstādīta spuldze.
---	---	---	---

C - 01

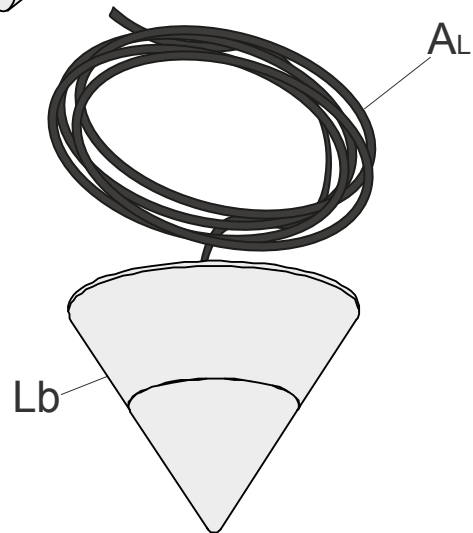
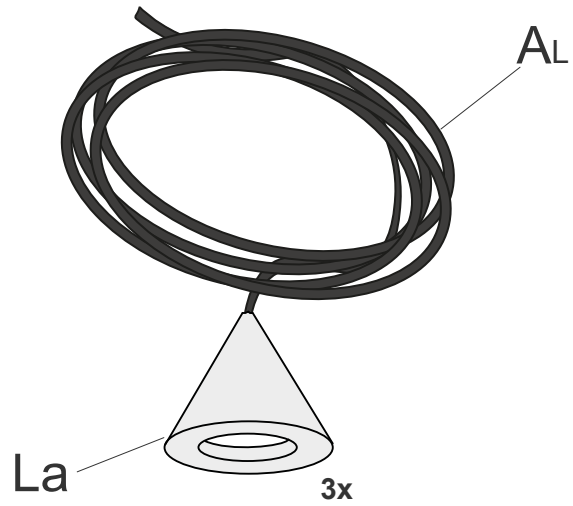
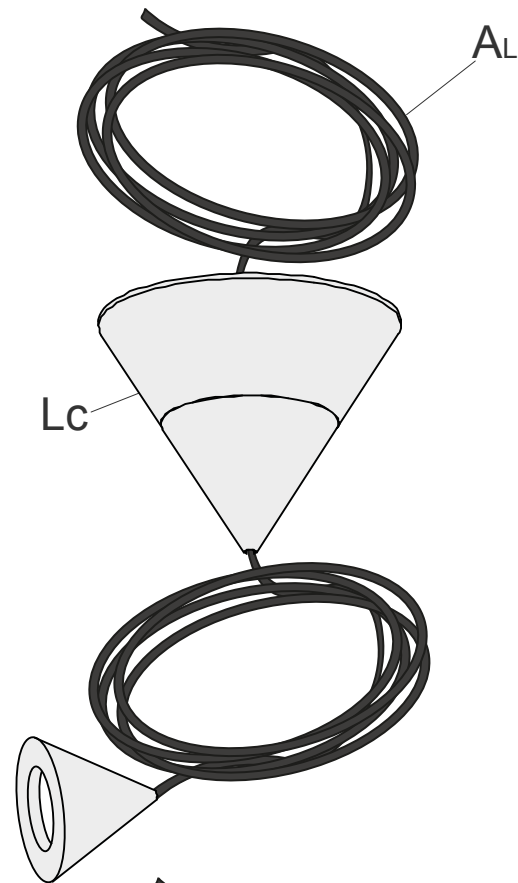
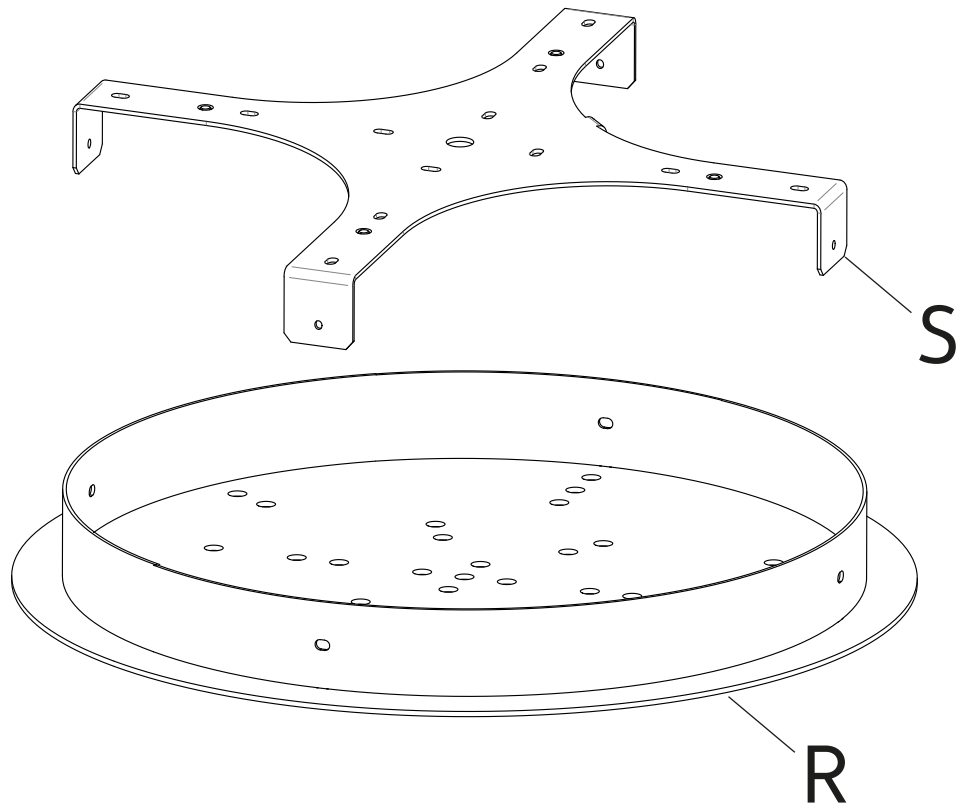

4x **F**

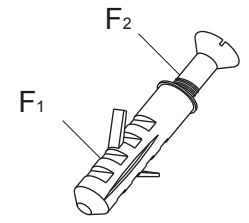

5x **B_o**



T

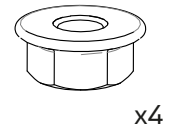

O

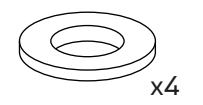

P

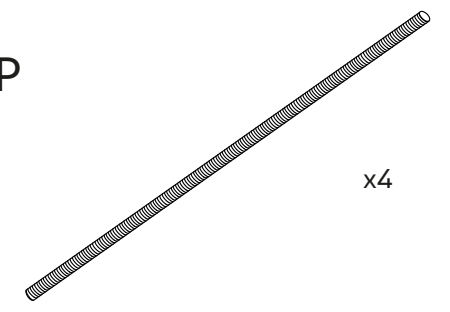

1

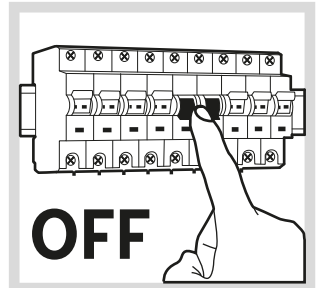
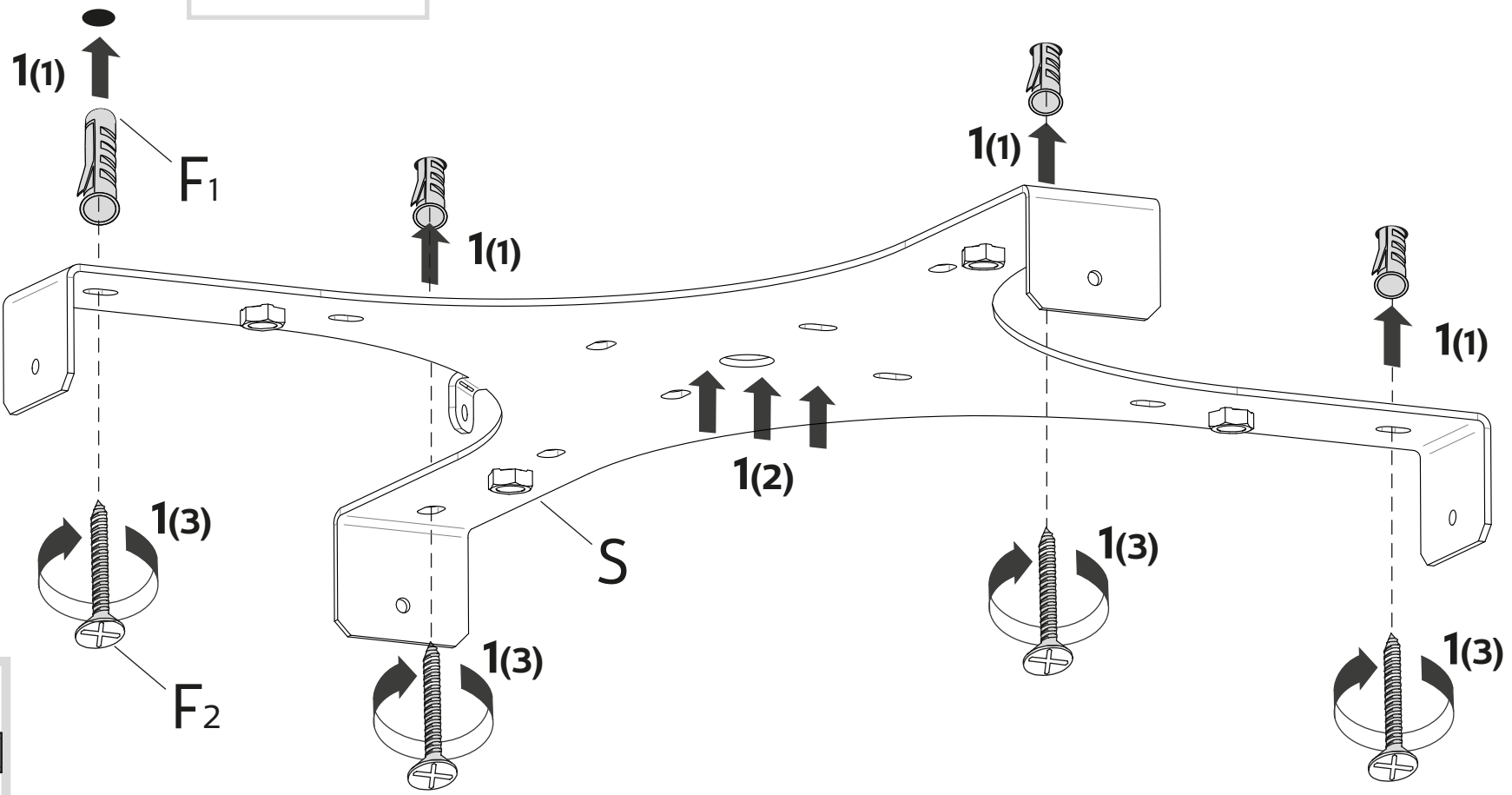
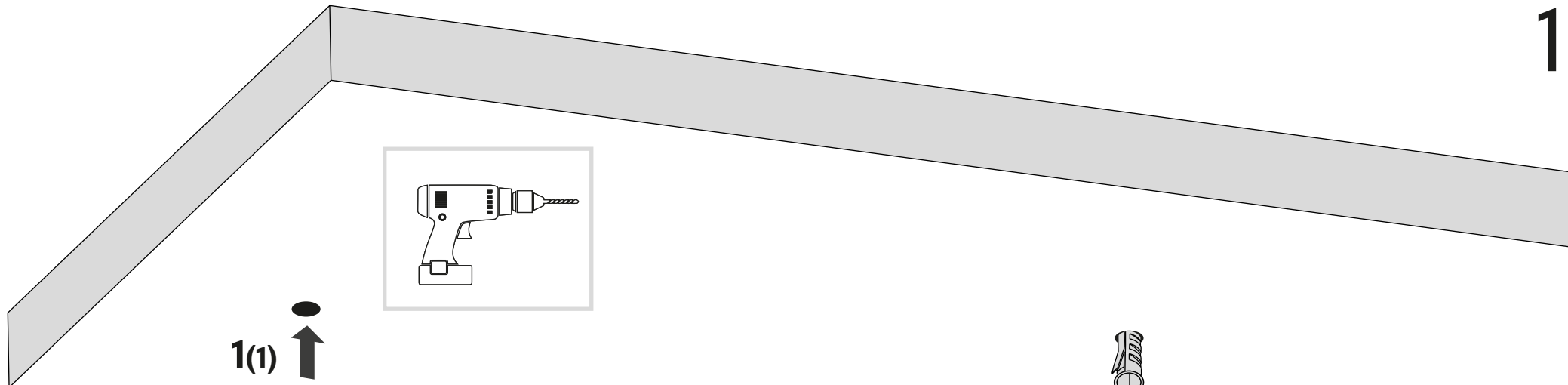
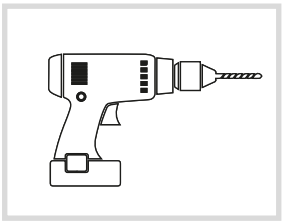

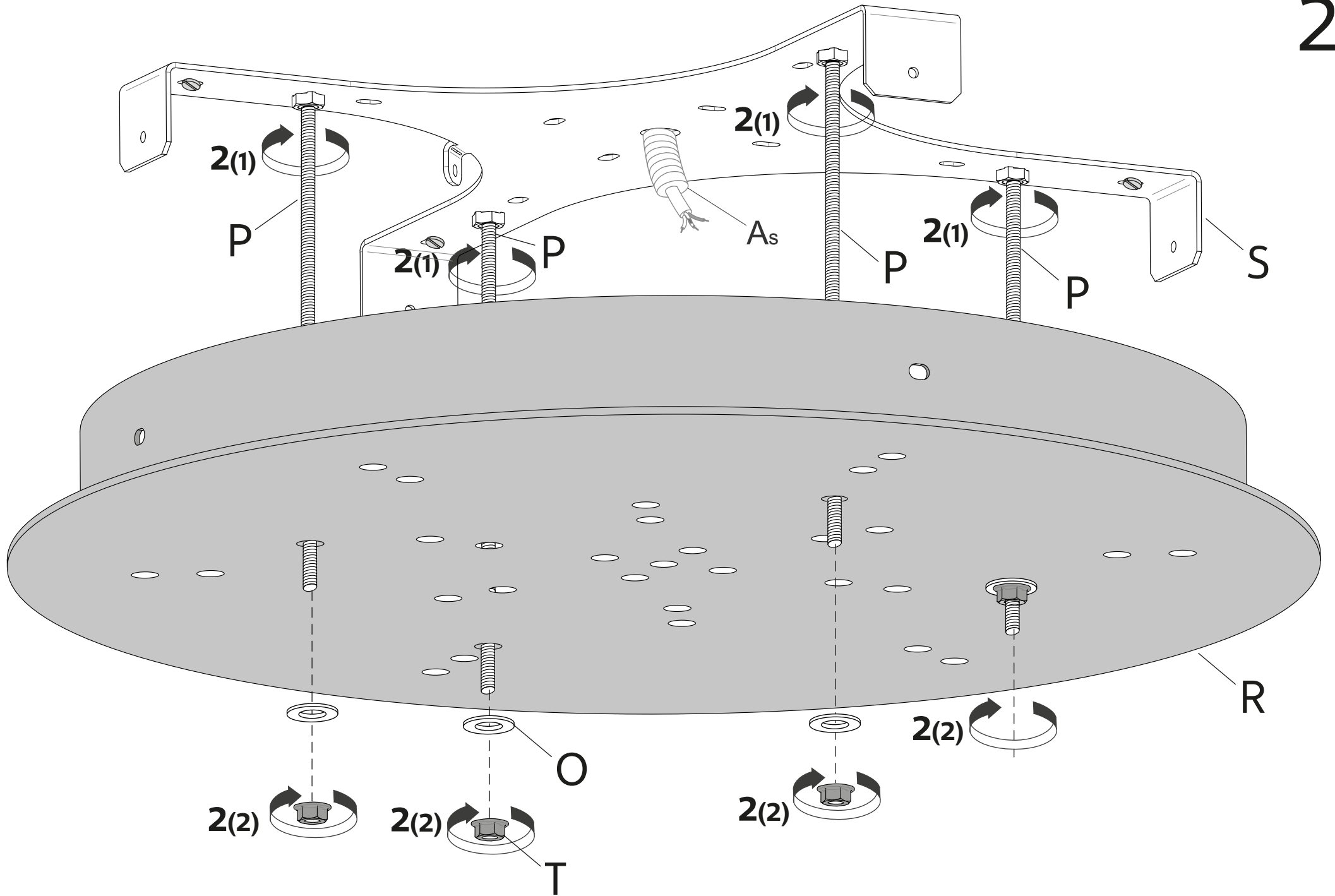

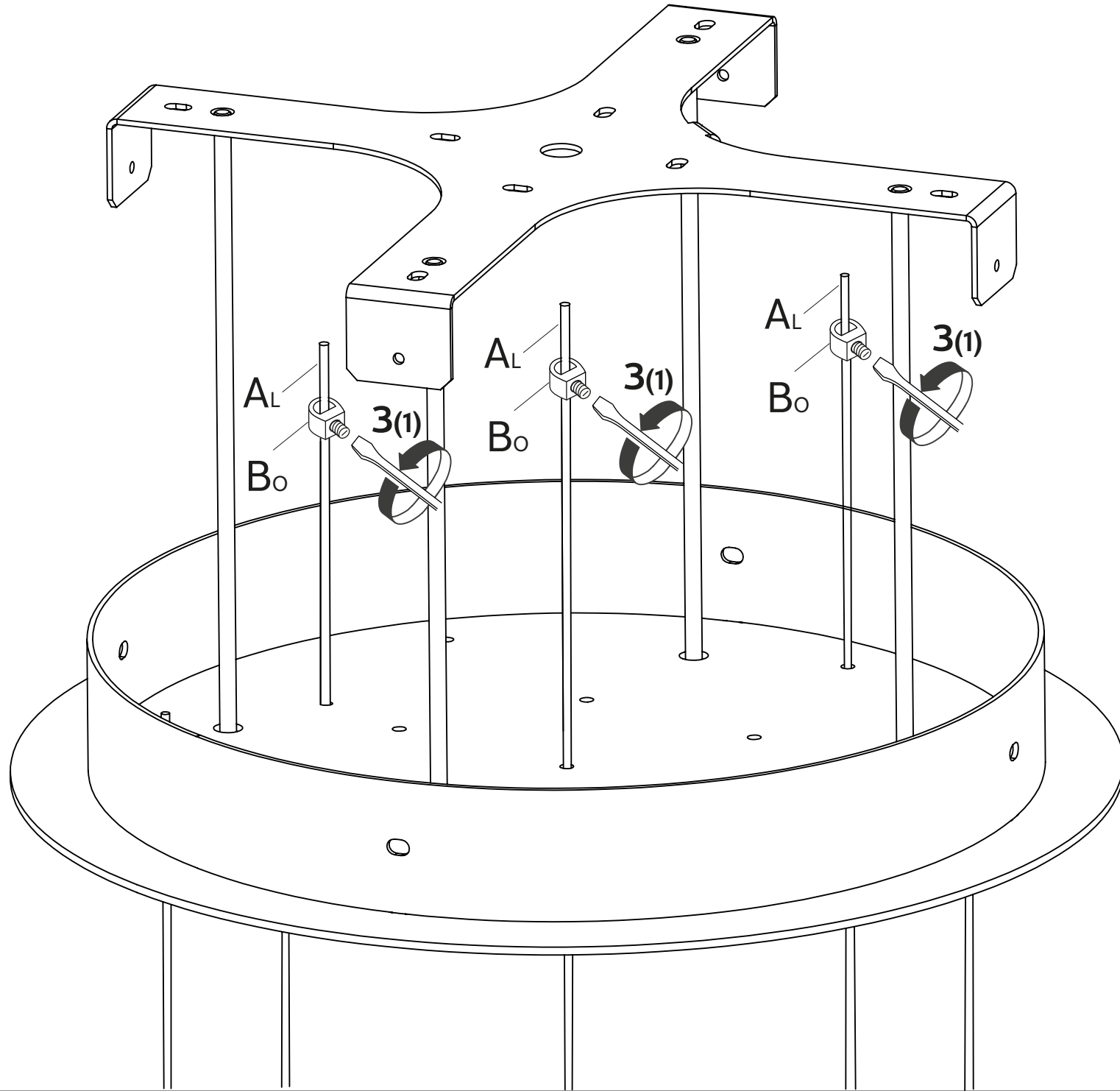

5

