

Bibendum

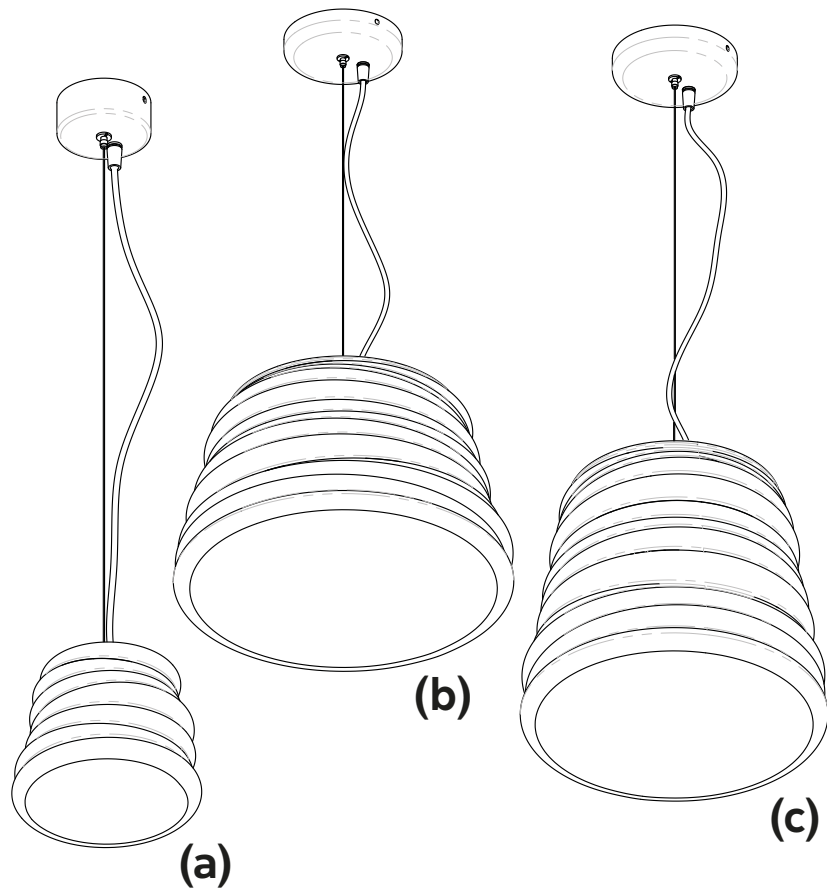

(a) SE198 DT
SE198 DD

(b) SE198 ET
SE198 ED

(c) SE198 FT
SE198 FD

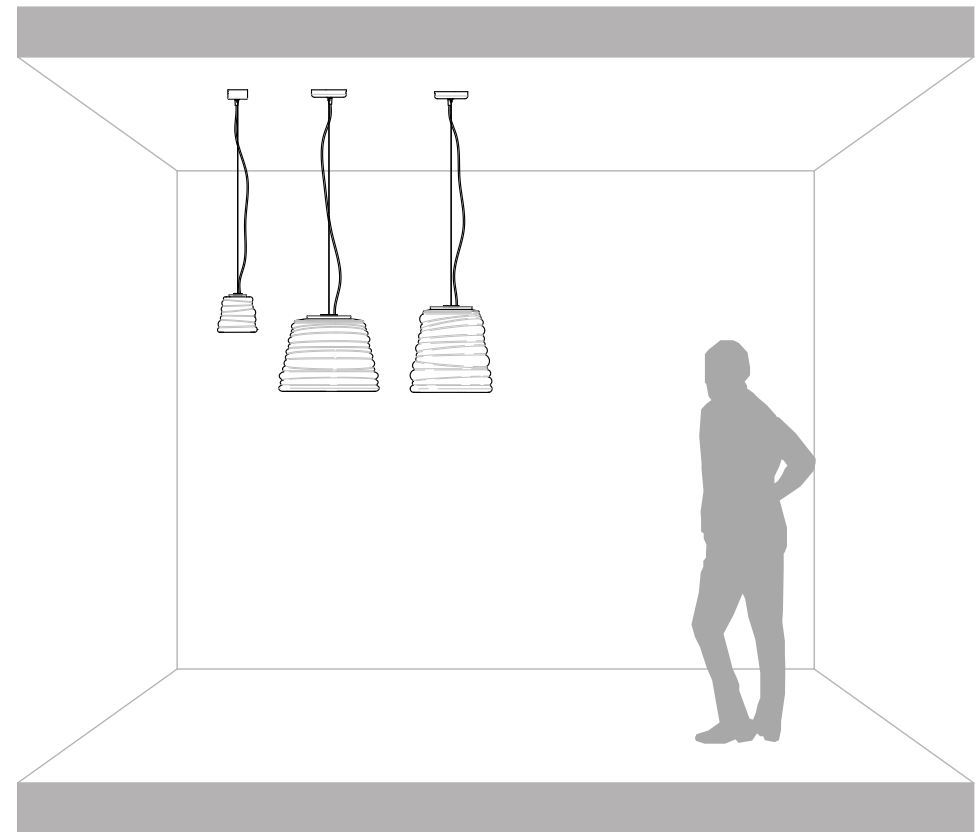

Karman srl

Via A. Grandi, San Martino del piano, 61034 Fossombrone (PU), Italy
p.iva 02175640412 tel +39 0721 71 5042 r.a fax +39 0721 716640 - www.karmanitalia.it

KARMAN

110 V.

1 x E12 max 6W Led (a)

1 x E26 max 18W Led (b/c)

DRY LOCATION

C - 01

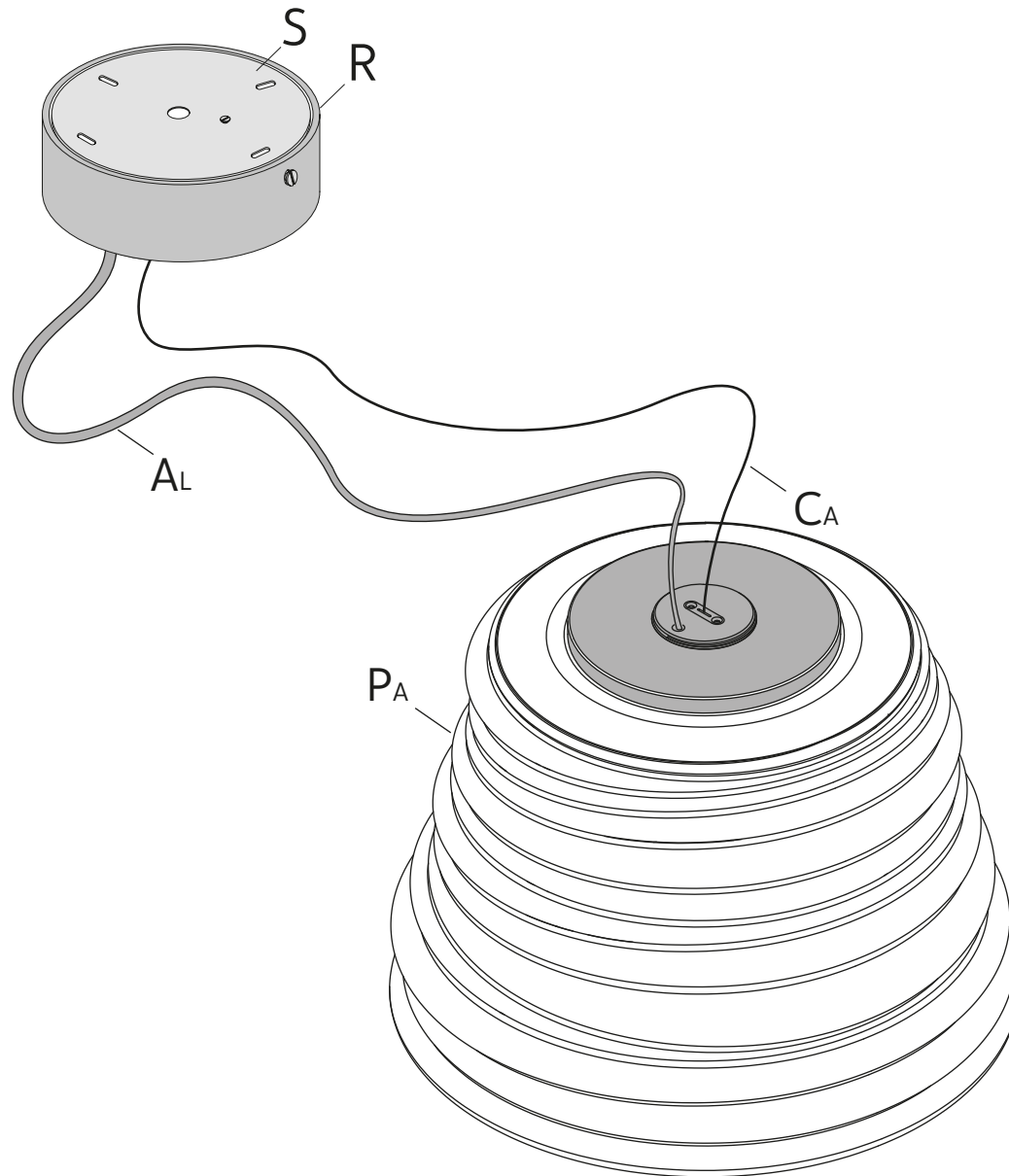

F

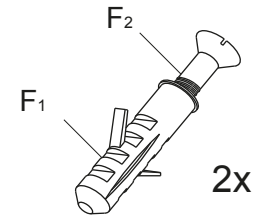

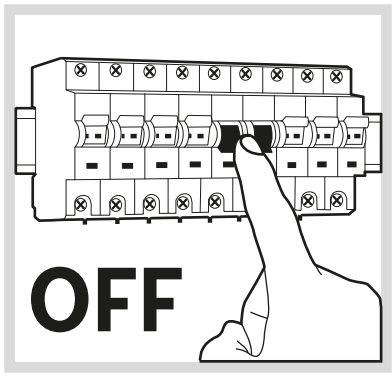

L 20 cm
L 7.87402 Inch

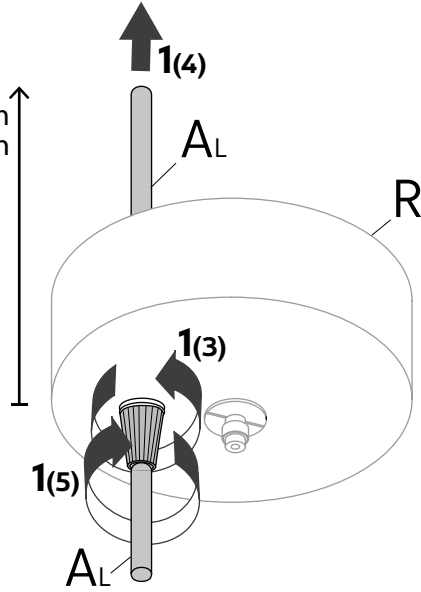
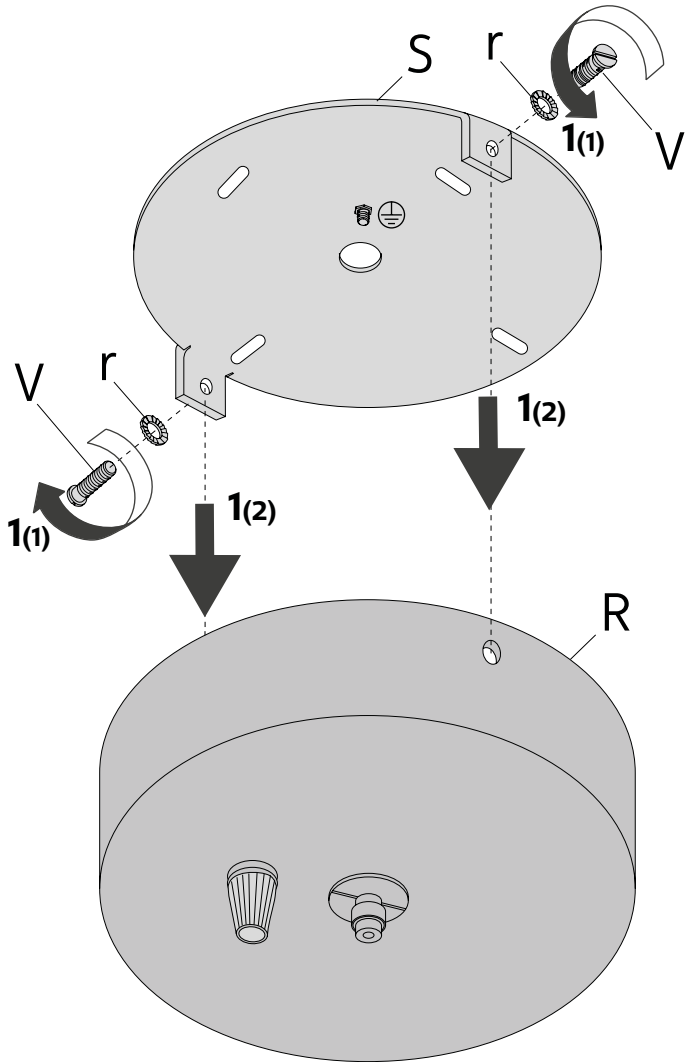

L 20 cm
L 7.87402 Inch

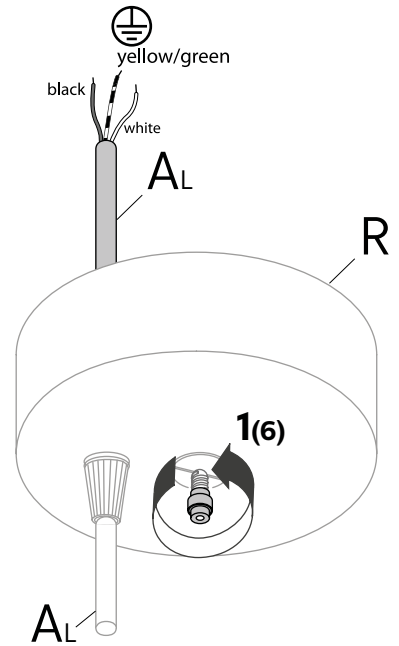

1

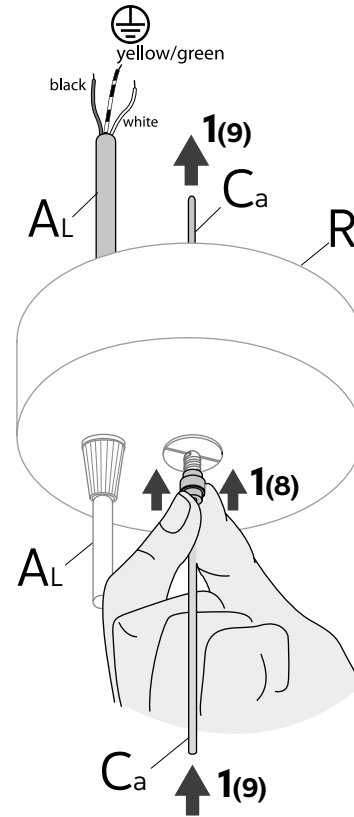

L 20 cm
L 7.87402 Inch

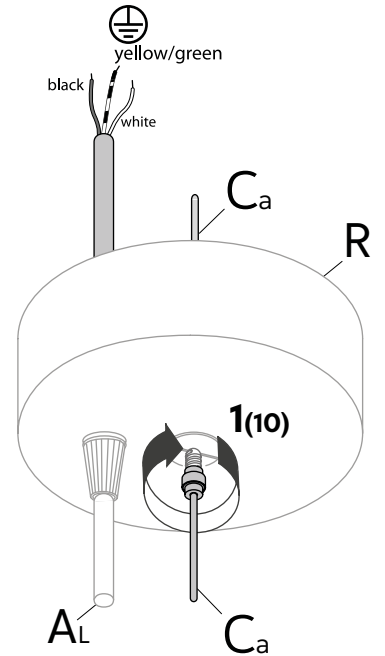

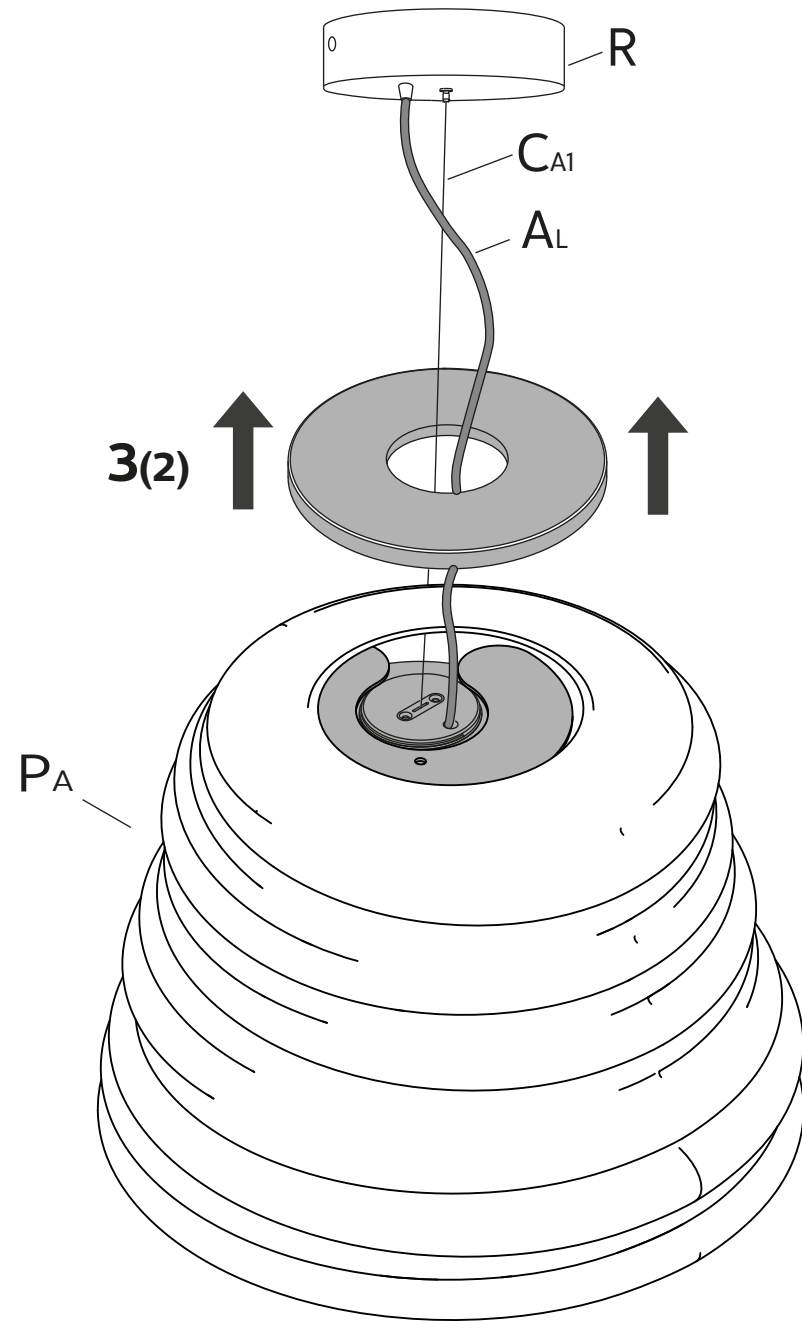
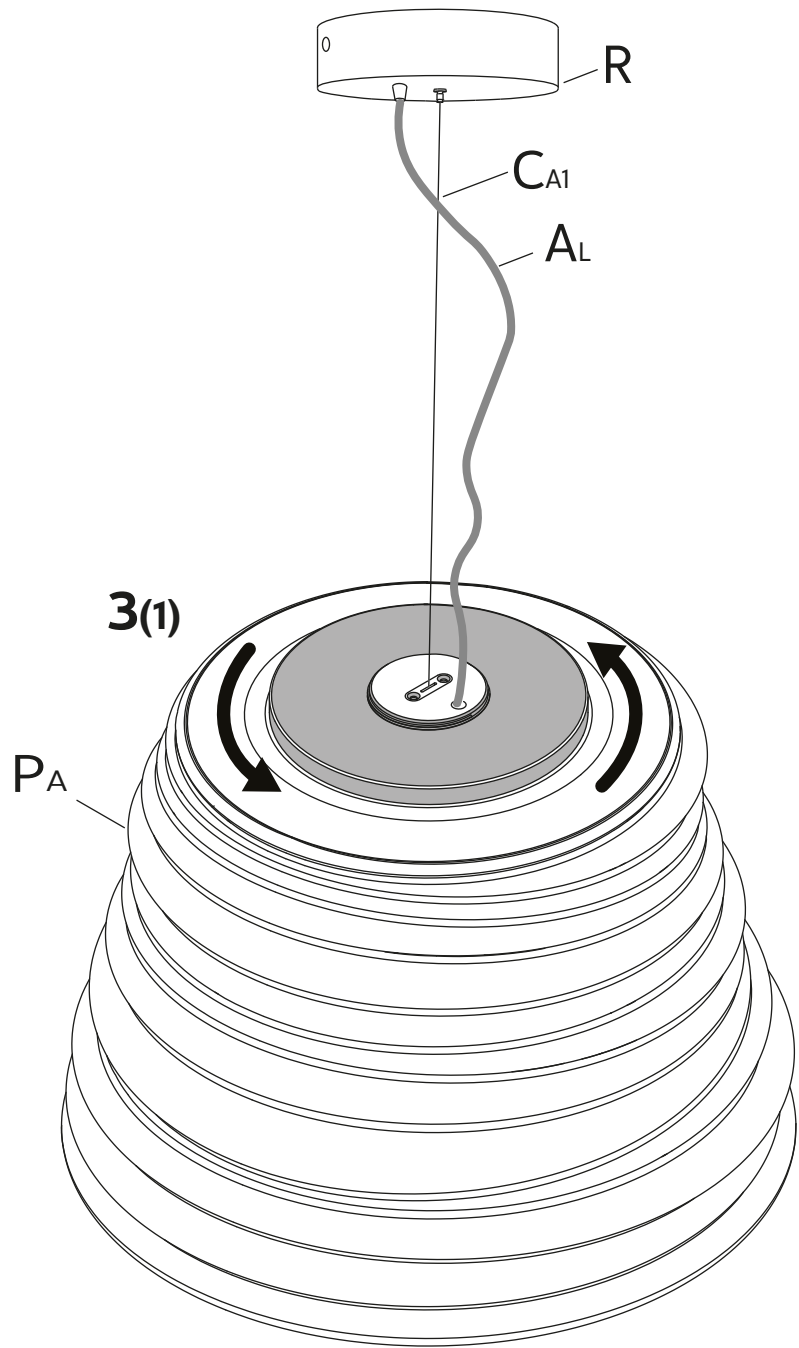

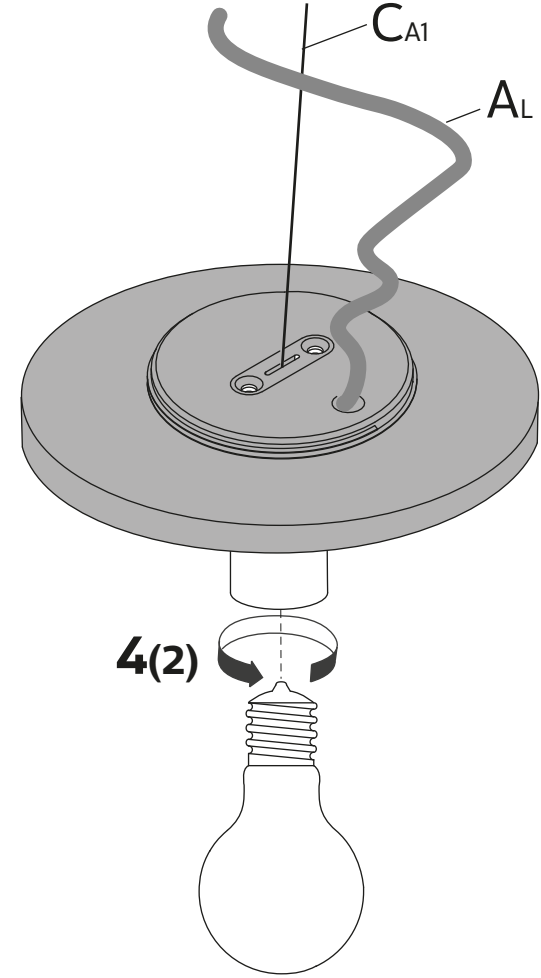
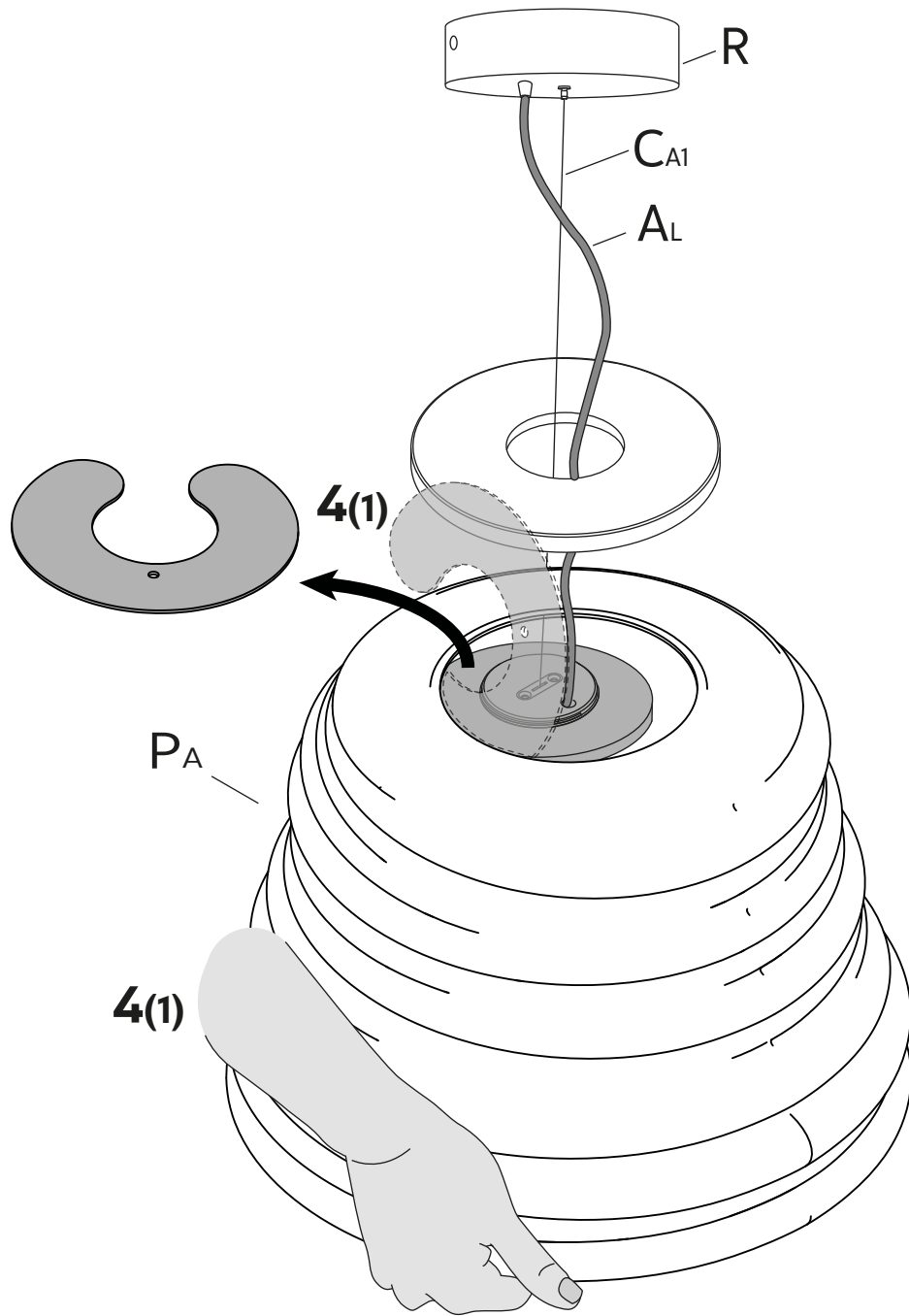

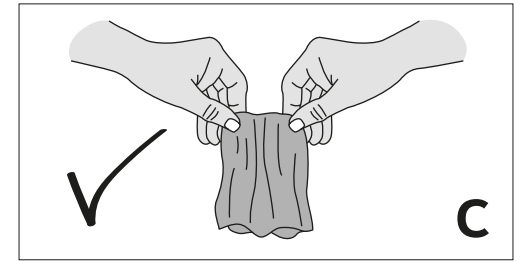
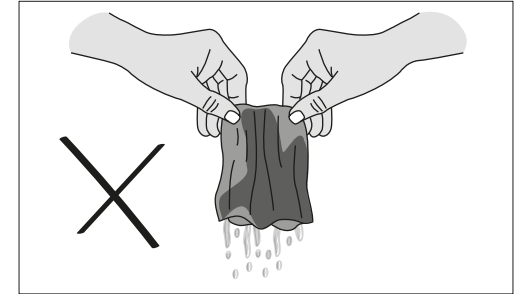
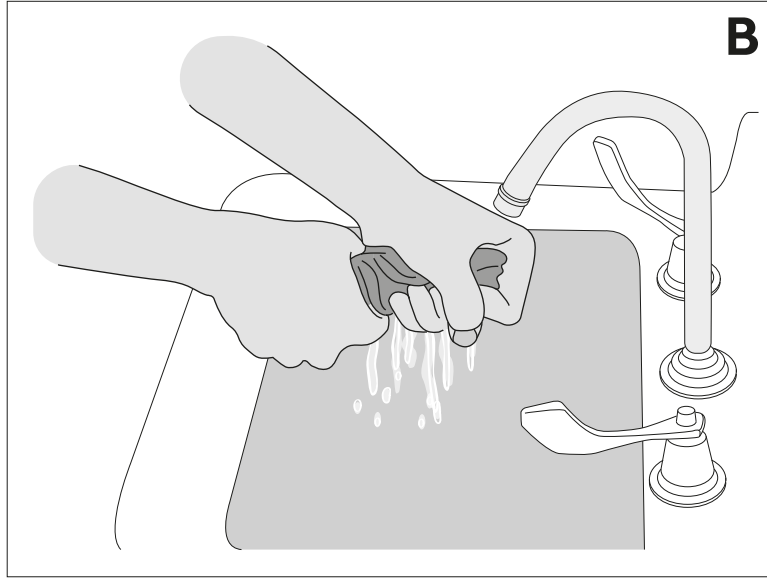
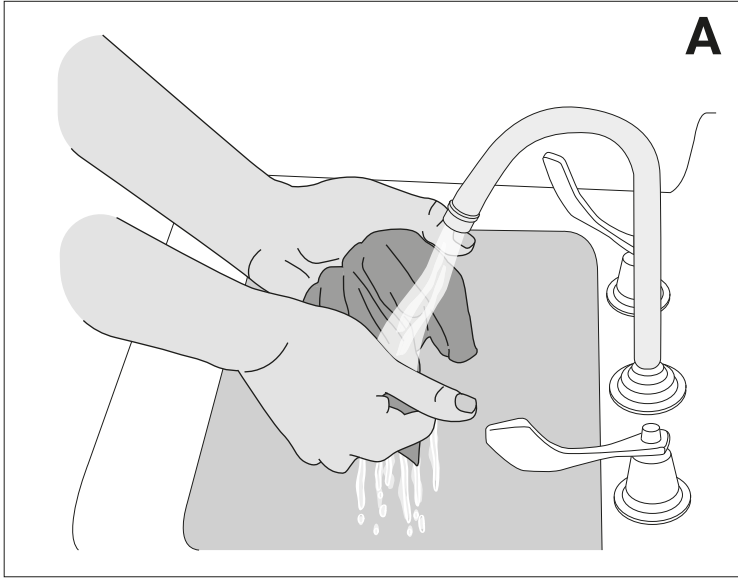

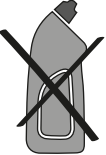

chemical agents



chemical agents



alcohol

