

CELL table lamp

Matteo Ugolini design

year 2012

TECHNICAL SHEET - M612-V1E

STRUCTURE "A"

material	steel inox	
colour	glossy white	

SHADE "B"

material	Pmma	
colour	white	

ELECTRICAL CABLE "C"

material	neoprene	
colour	green	

ELECTRICAL SYSTEM

socket	E26
source	max 1x18w LED
energy class	from E to A++





PACKAGING

nr. of collis	1
net weight/kg	7,9
gross weight/kg	10
packaging/cm	63x63x67

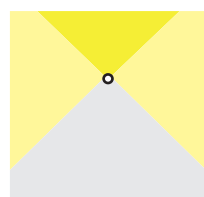
EMISSION OF LIGHT

one-directional



	direct
	filtered
	indirect
	none

bulb not provided

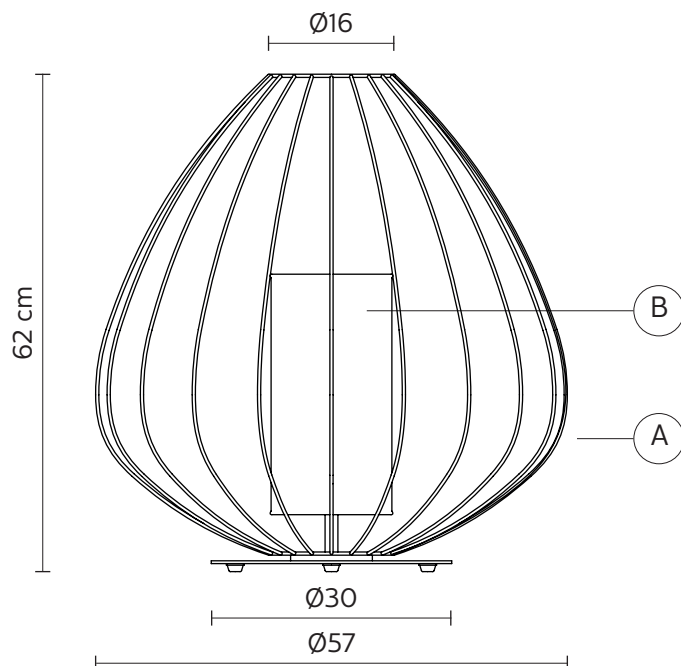

COLLECTION

available also as: suspension (in/outdoor)

