

# DON'T TOUCH

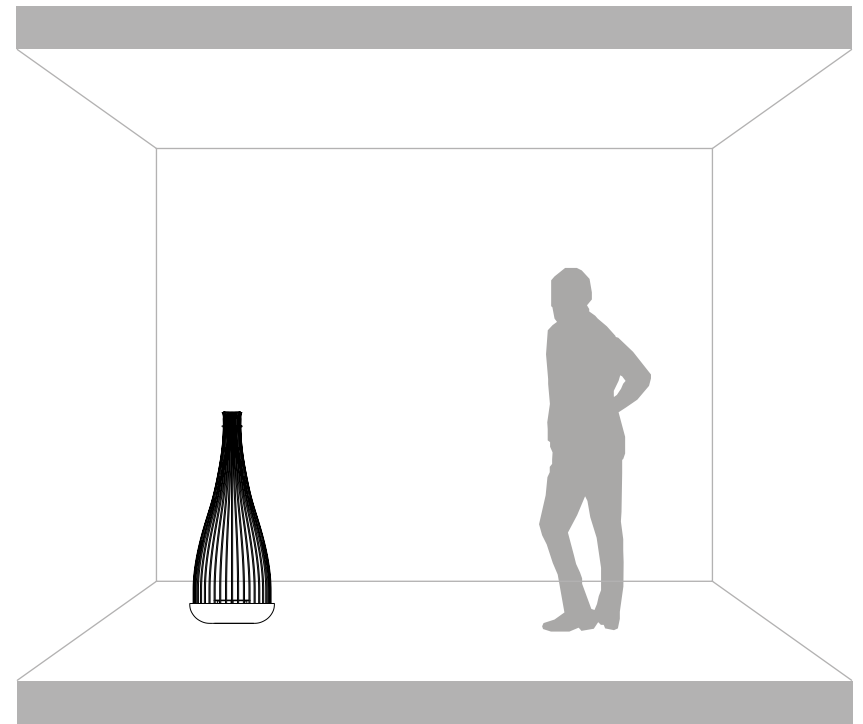

**HP153 AB V1U (3000K)**  
**HP153 BB V1U (2700K)**

**110-120V**  
**LED 16,7W, 2160lumen**  
**3000K/2700K CRI ≥80**



**DRY LOCATION**



C - 01

x 120 pz

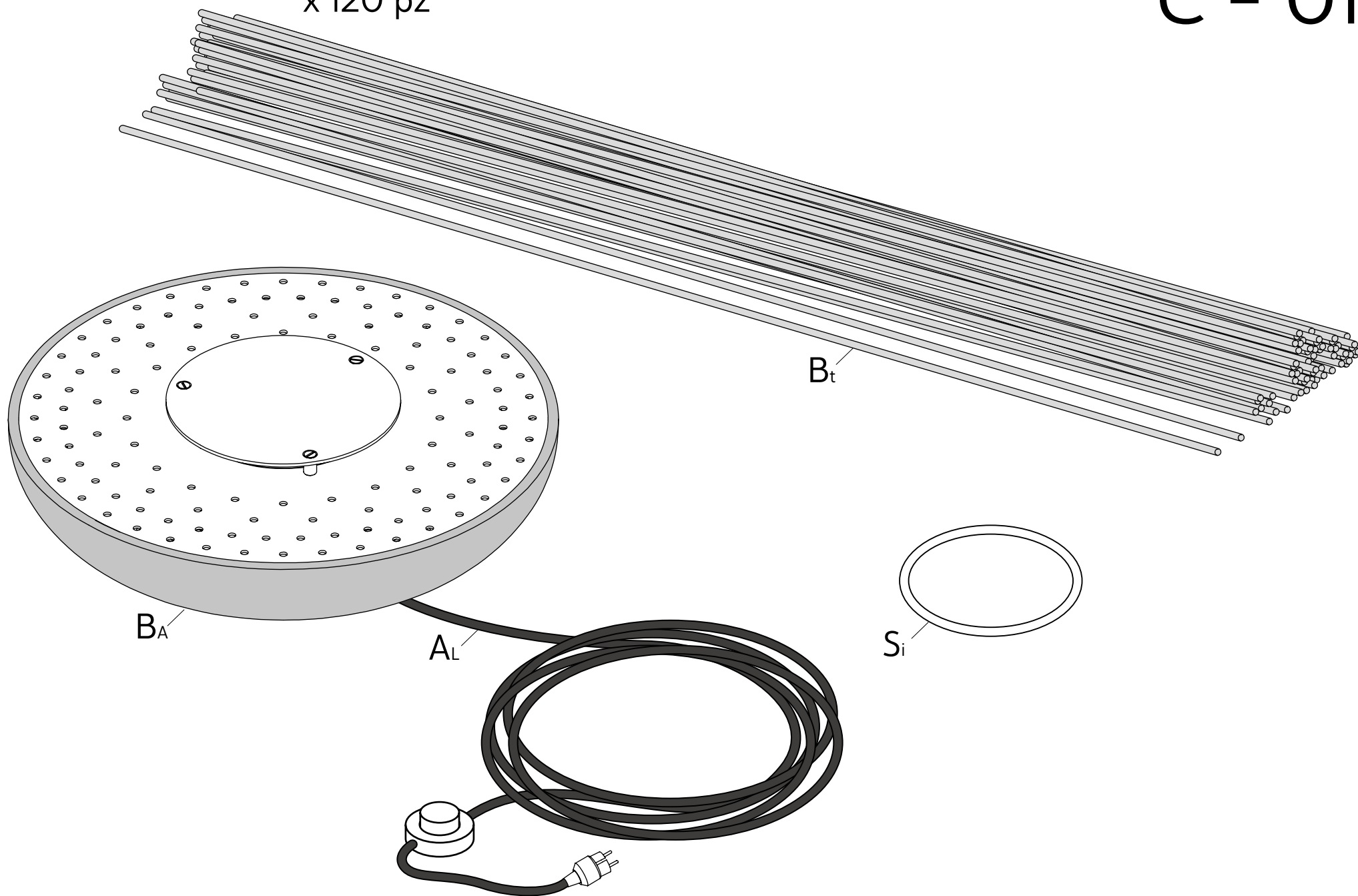

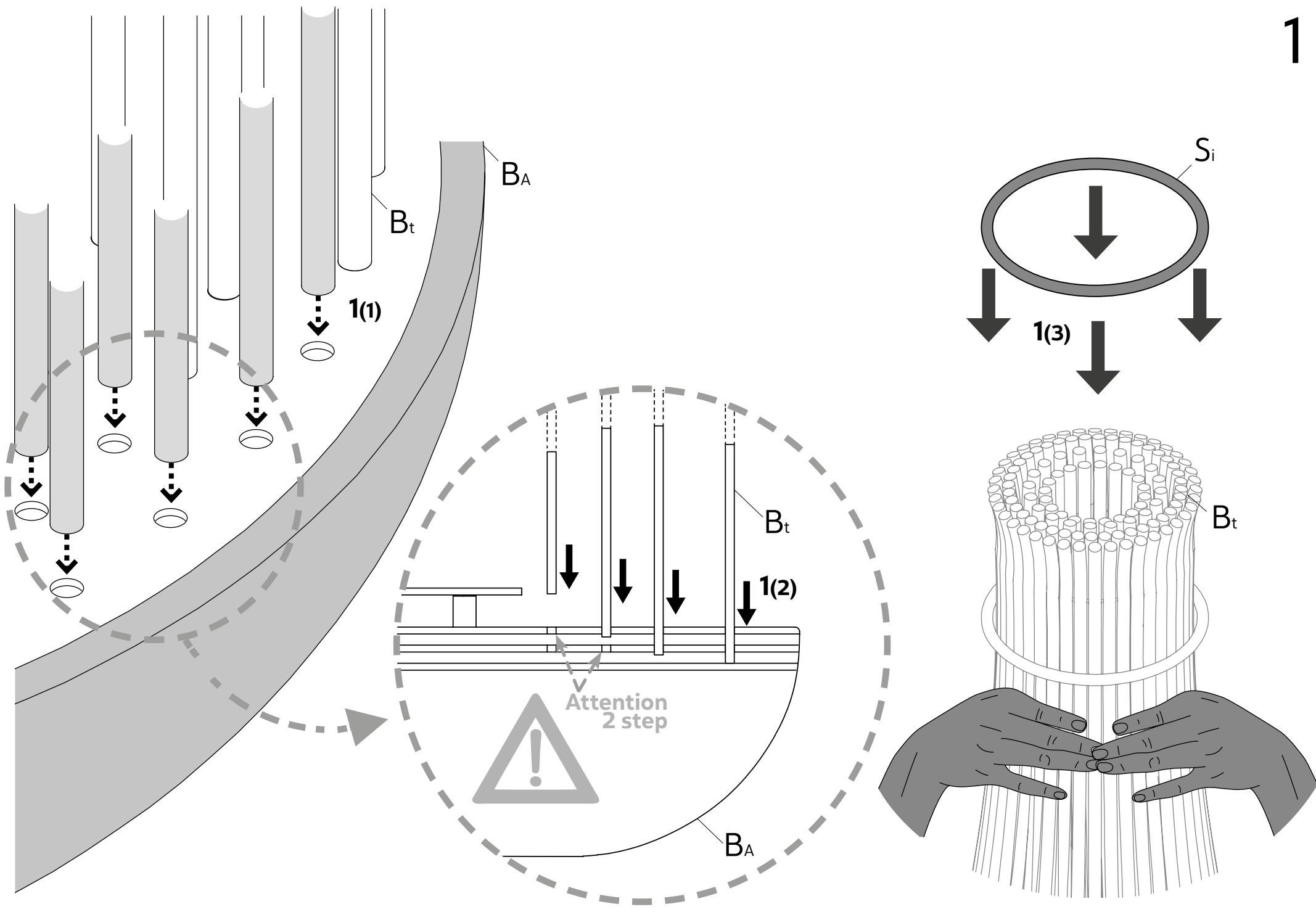

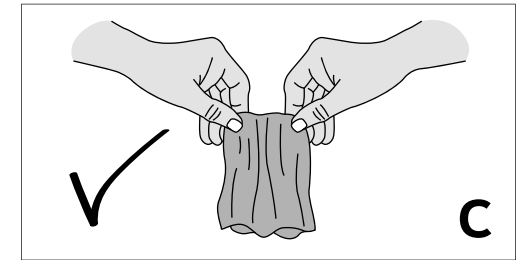
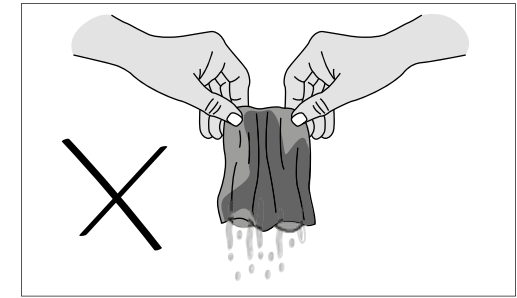
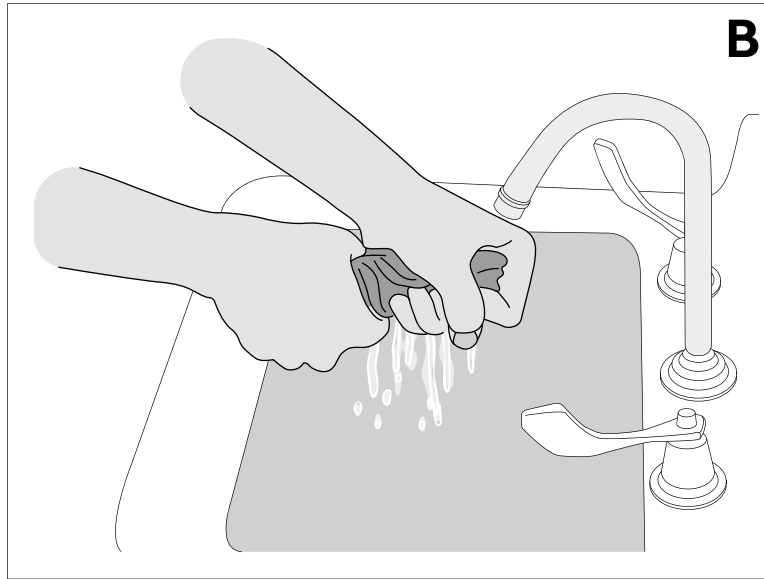

chemical agents

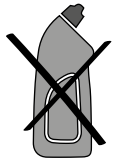

chemical agents



alcohol

