

# CERAUNAVOLTA

SE134 2S V1A (a)

SE134 2T V1A (a)

SE134 3S V1C (a)

SE134 3T V1C (a)

SE134 1S V1D (b)

SE134 1T V1D (b)

110V

3 x max 20W LED - E26

4 x max 20W LED - E26

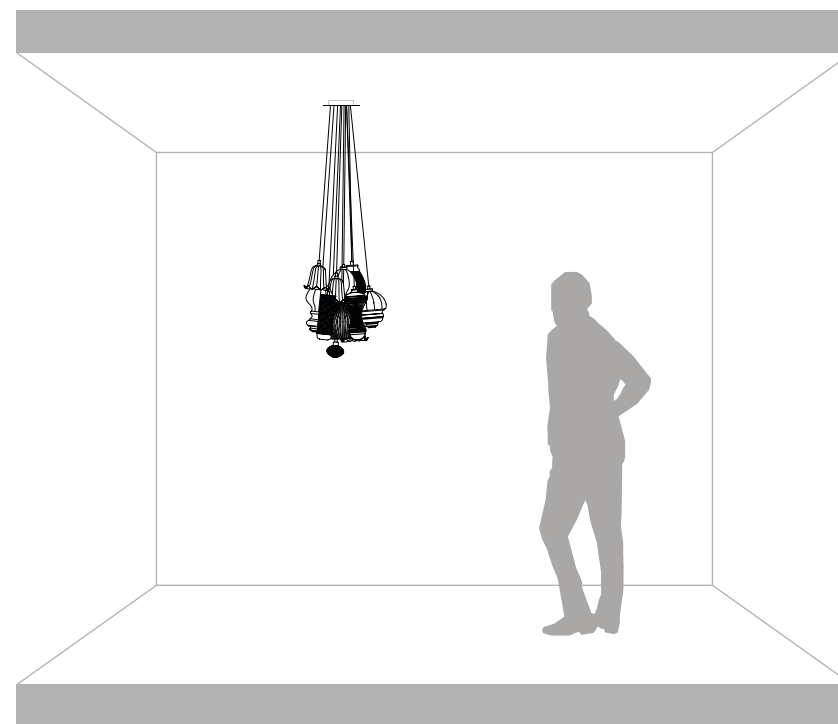

**DRY LOCATION**



# C - 01

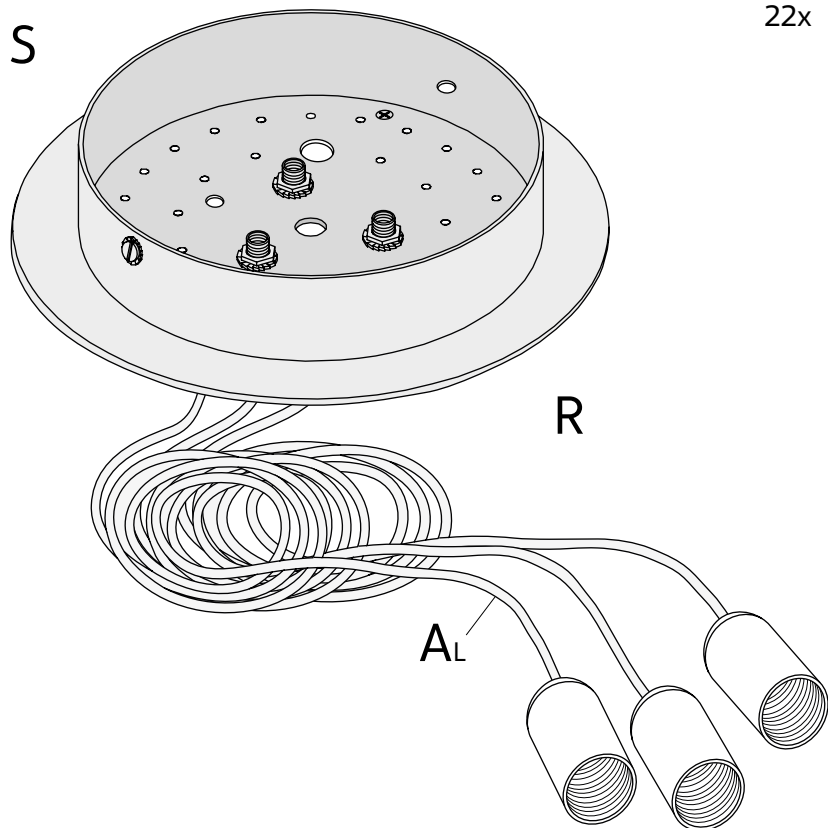

12x **C<sub>a</sub>** SE134 2S 00A  
SE134 2T 00A

17x **C<sub>a</sub>** SE134 3S 00C  
SE134 3T 00C

22x **C<sub>a</sub>** SE134 1S 00D  
SE134 1T 00D

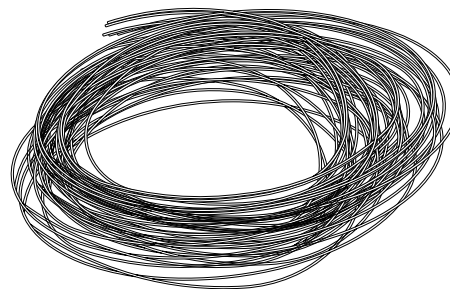

3x **mo**

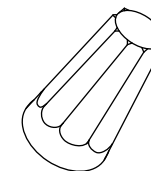

12x **T** SE134 2S 00A  
SE134 2T 00A

17x **T** SE134 3S 00C  
SE134 3T 00C

22x **T** SE134 1S 00D  
SE134 1T 00D

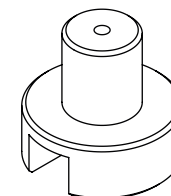

12x **O** SE134 2S 00A  
SE134 2T 00A

17x **O** SE134 3S 00C  
SE134 3T 00C

22x **O** SE134 1S 00D  
SE134 1T 00D



12x **A** SE134 2S 00A  
SE134 2T 00A

17x **A** SE134 3S 00C  
SE134 3T 00C

22x **A** SE134 1S 00D  
SE134 1T 00D

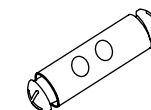

12x **P<sub>A</sub>** SE134 2S 00A  
SE134 2T 00A

17x **P<sub>A</sub>** SE134 3S 00C  
SE134 3T 00C

17x **C<sub>a</sub>** SE134 1S 00D  
SE134 1T 00D



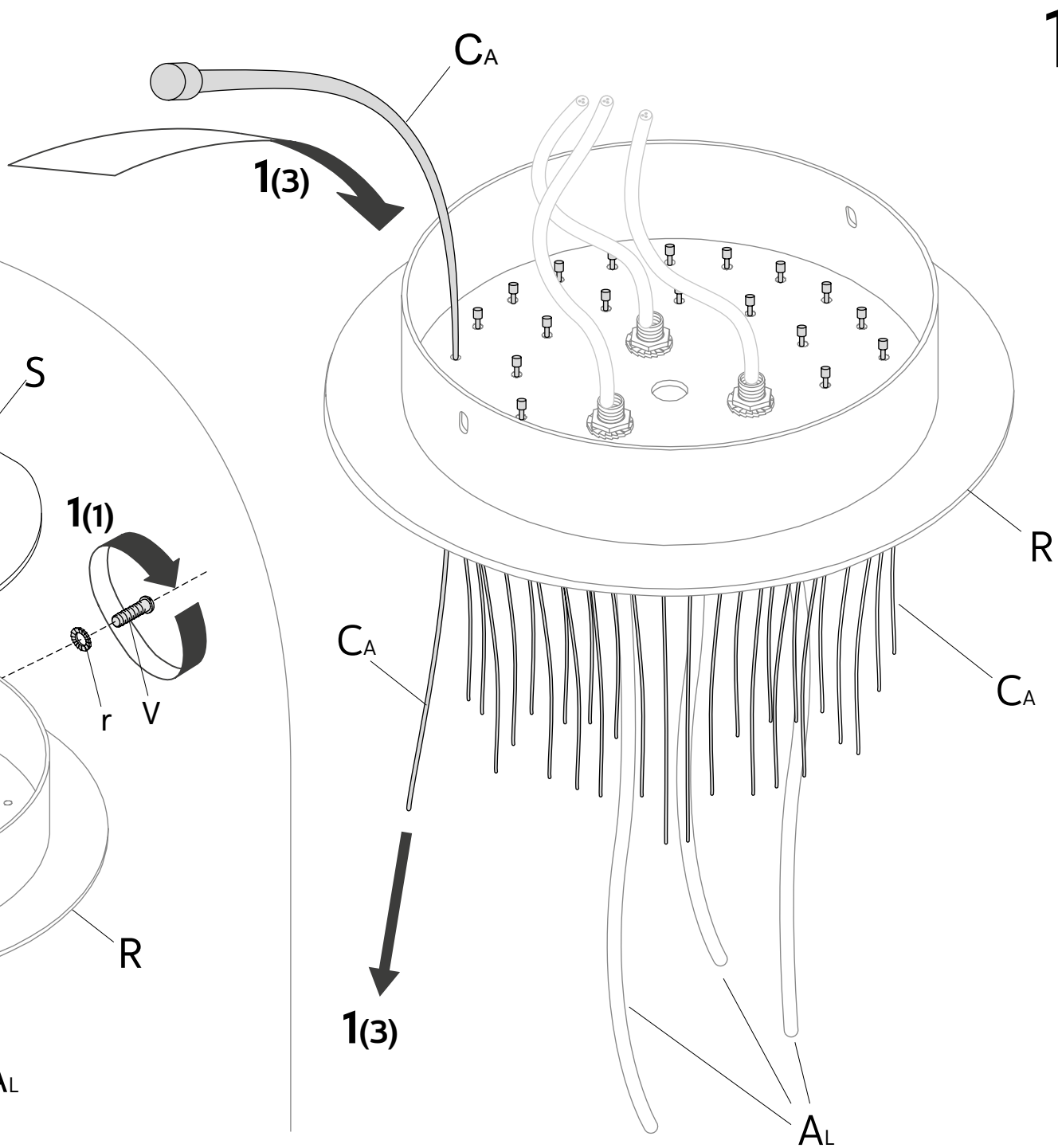
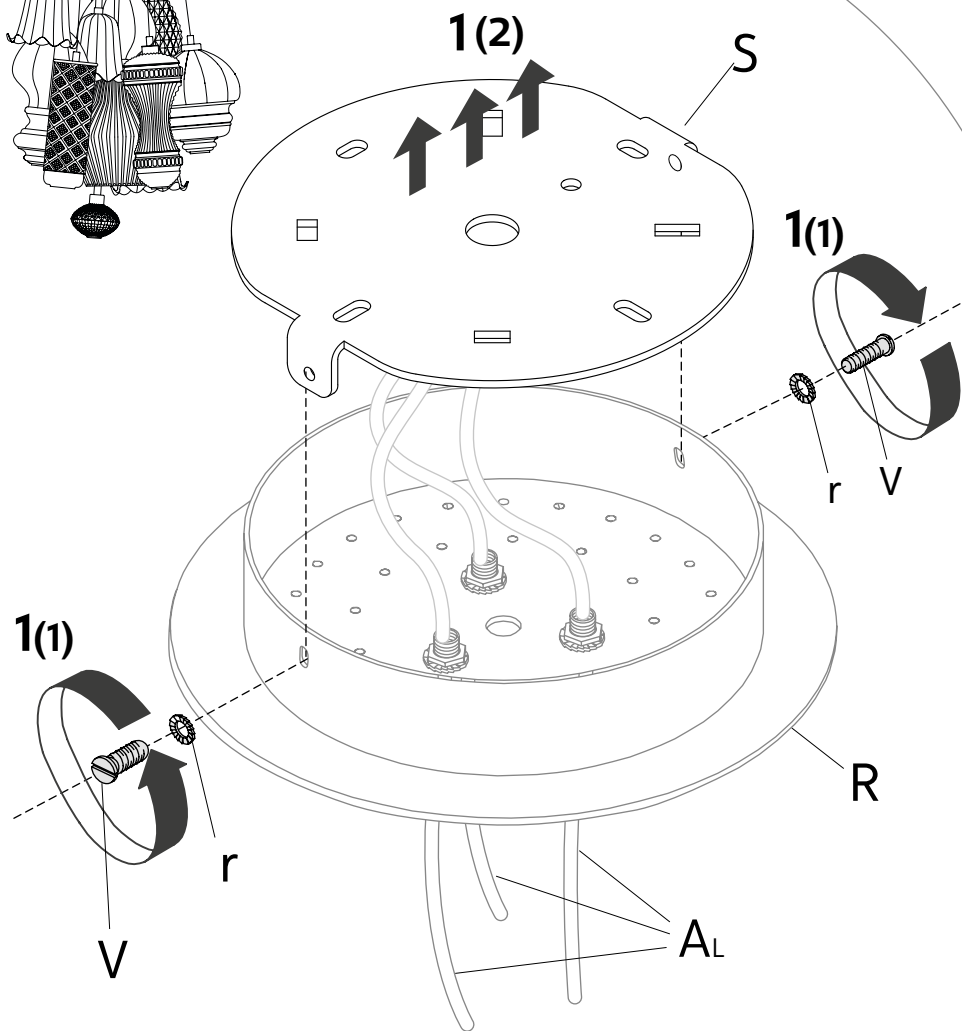
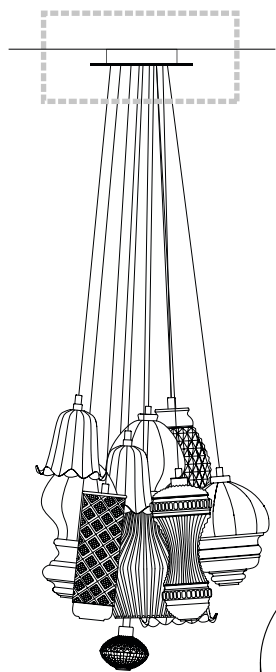

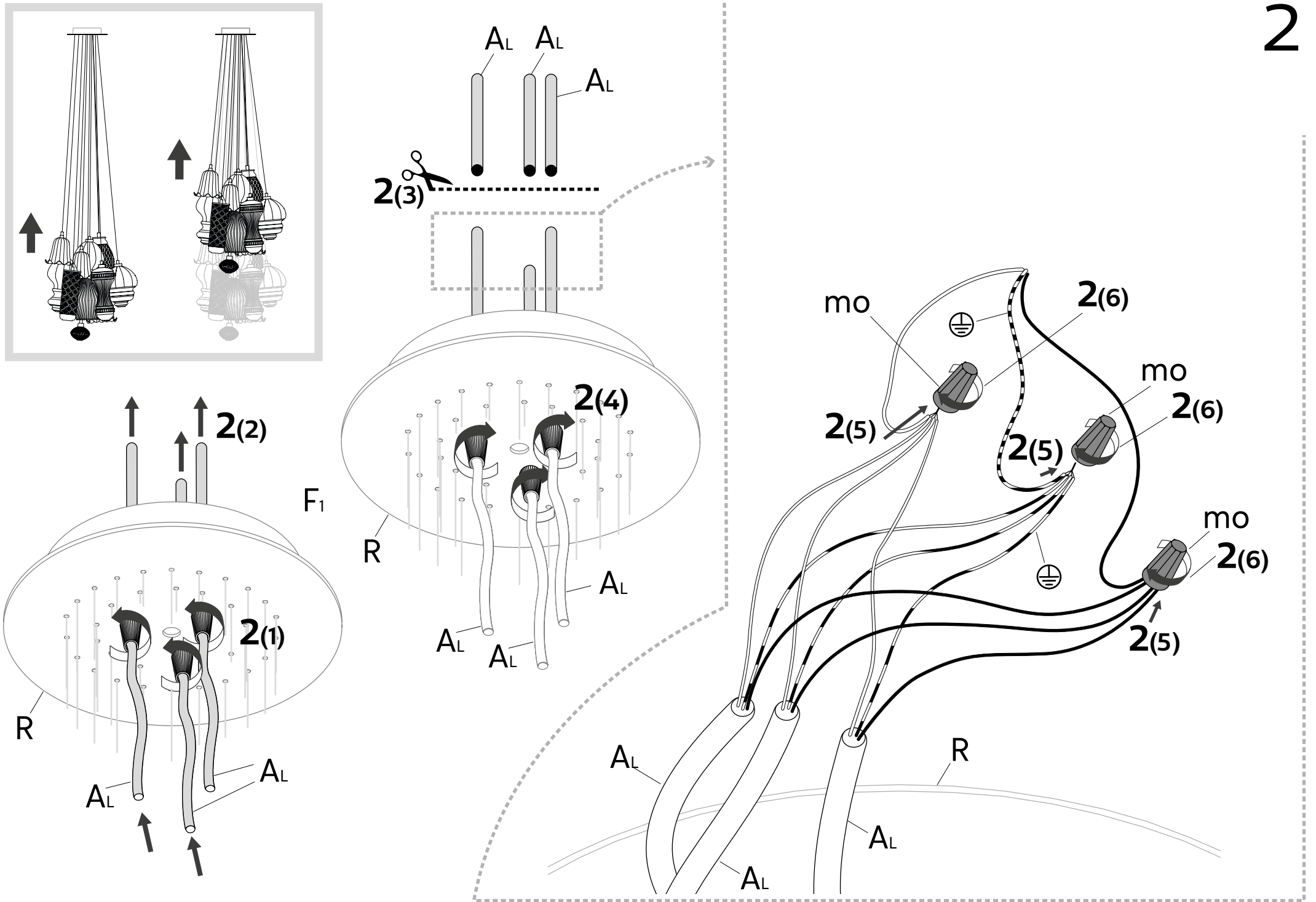

# Junction Box

