

# CAPODIMONTE

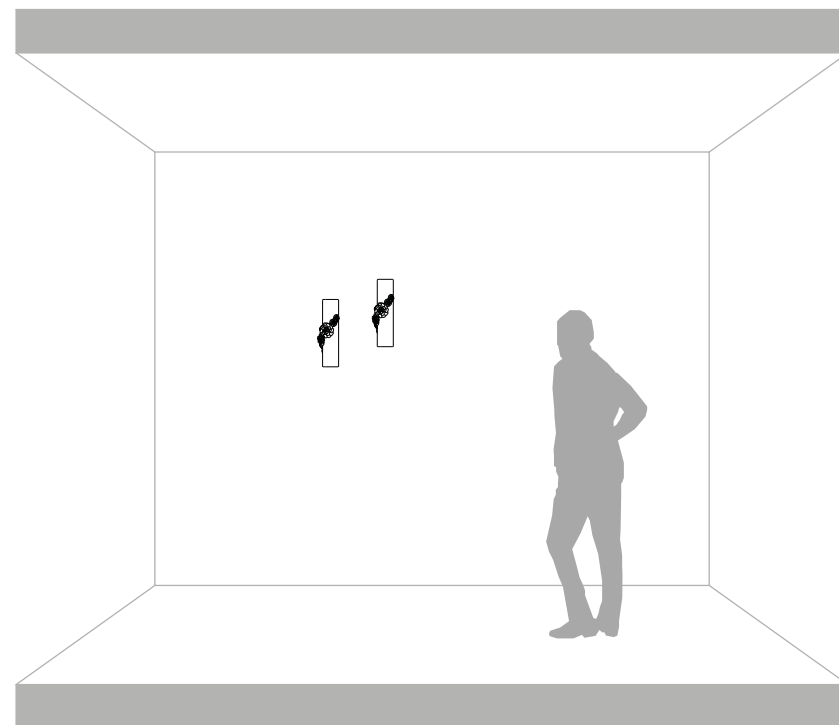

**AP129 1B V11**

**110 V.  
max 1x35W - GU10**



**DRY LOCATION**



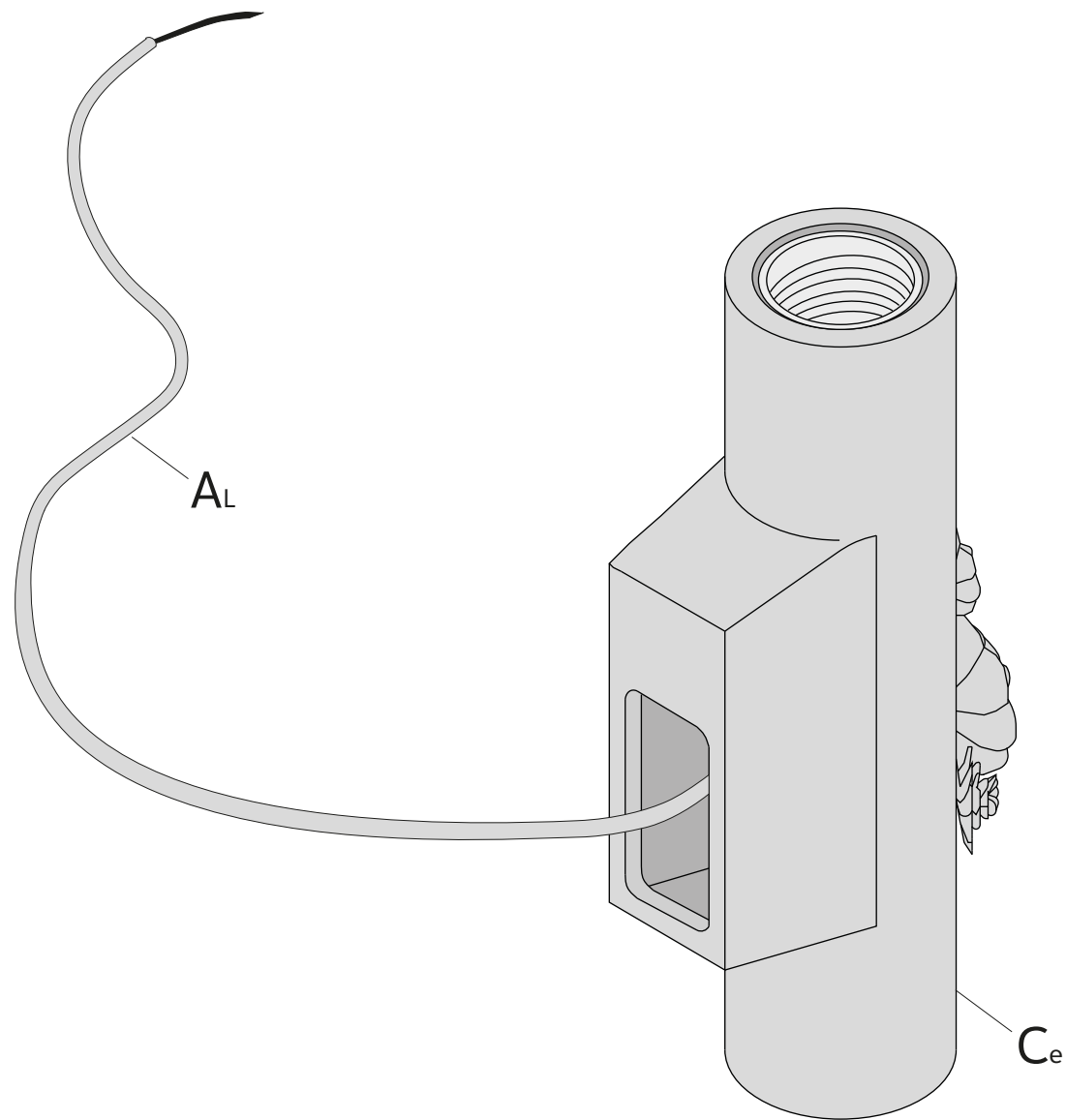

2X **F**

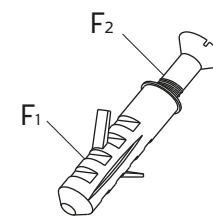

1X **S**

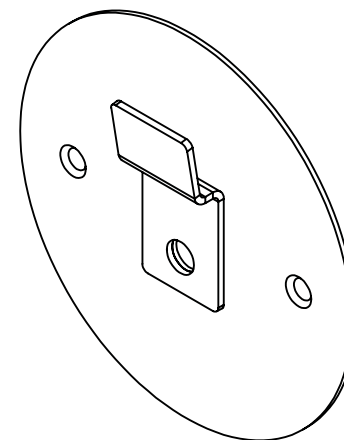

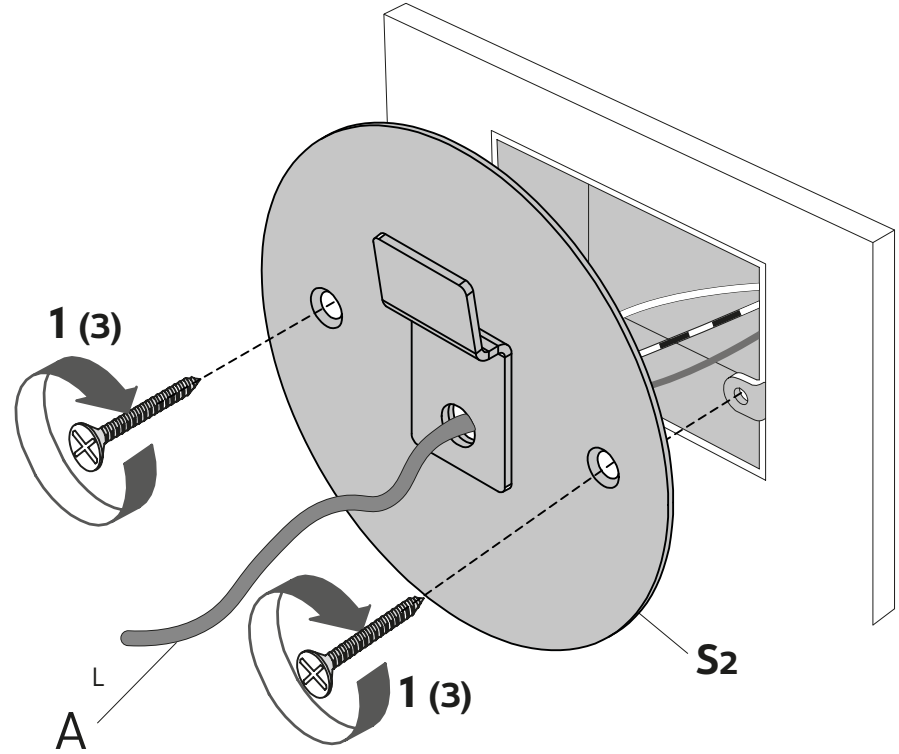
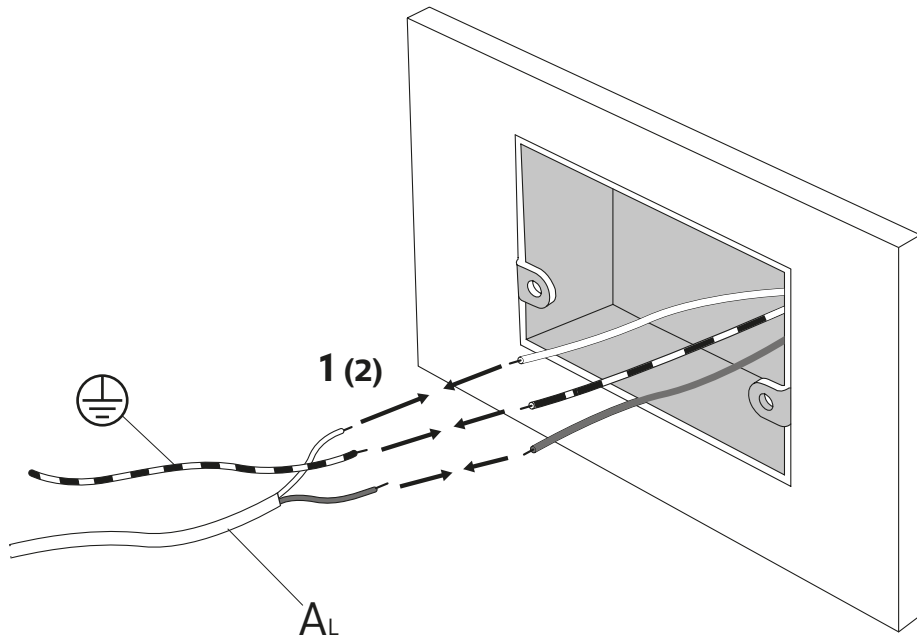
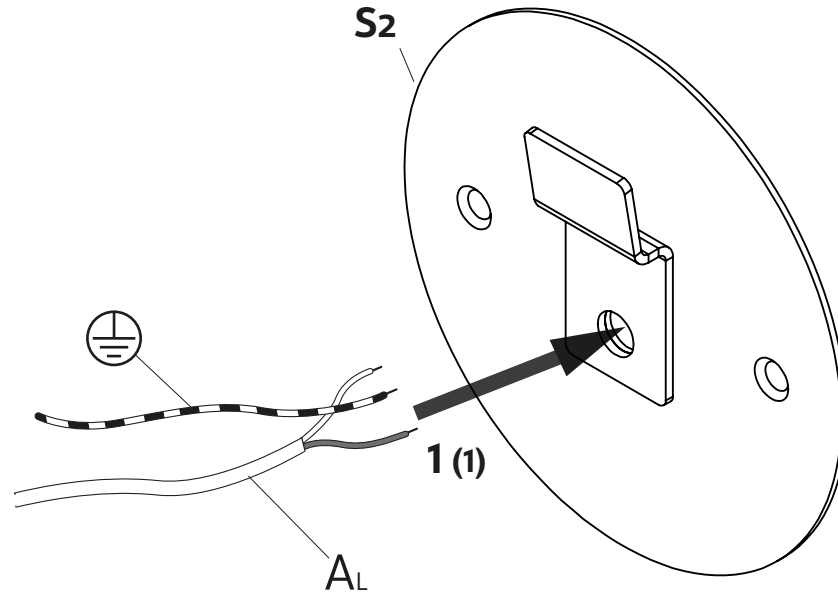
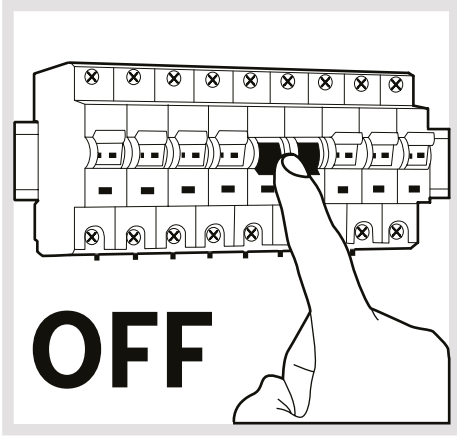

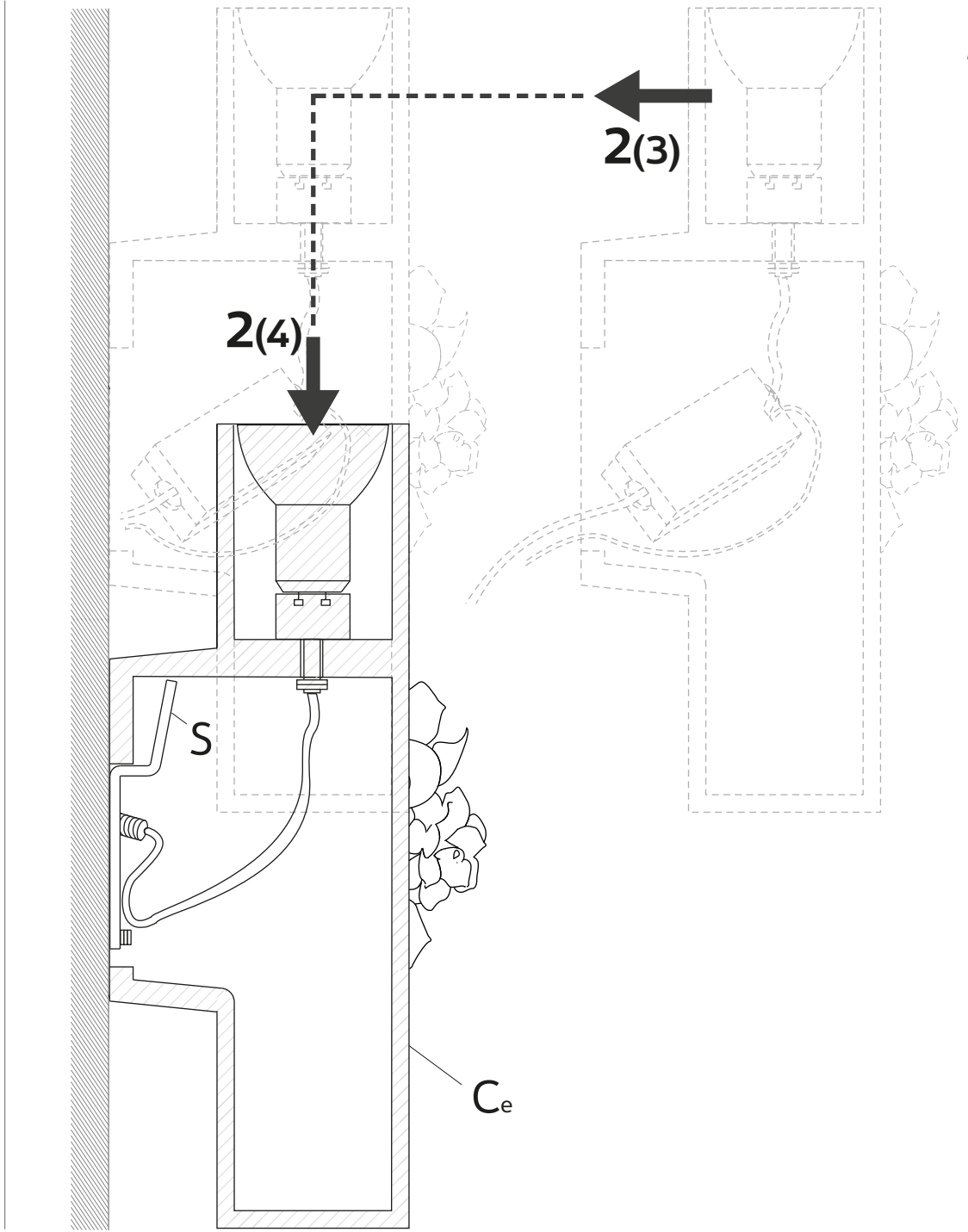
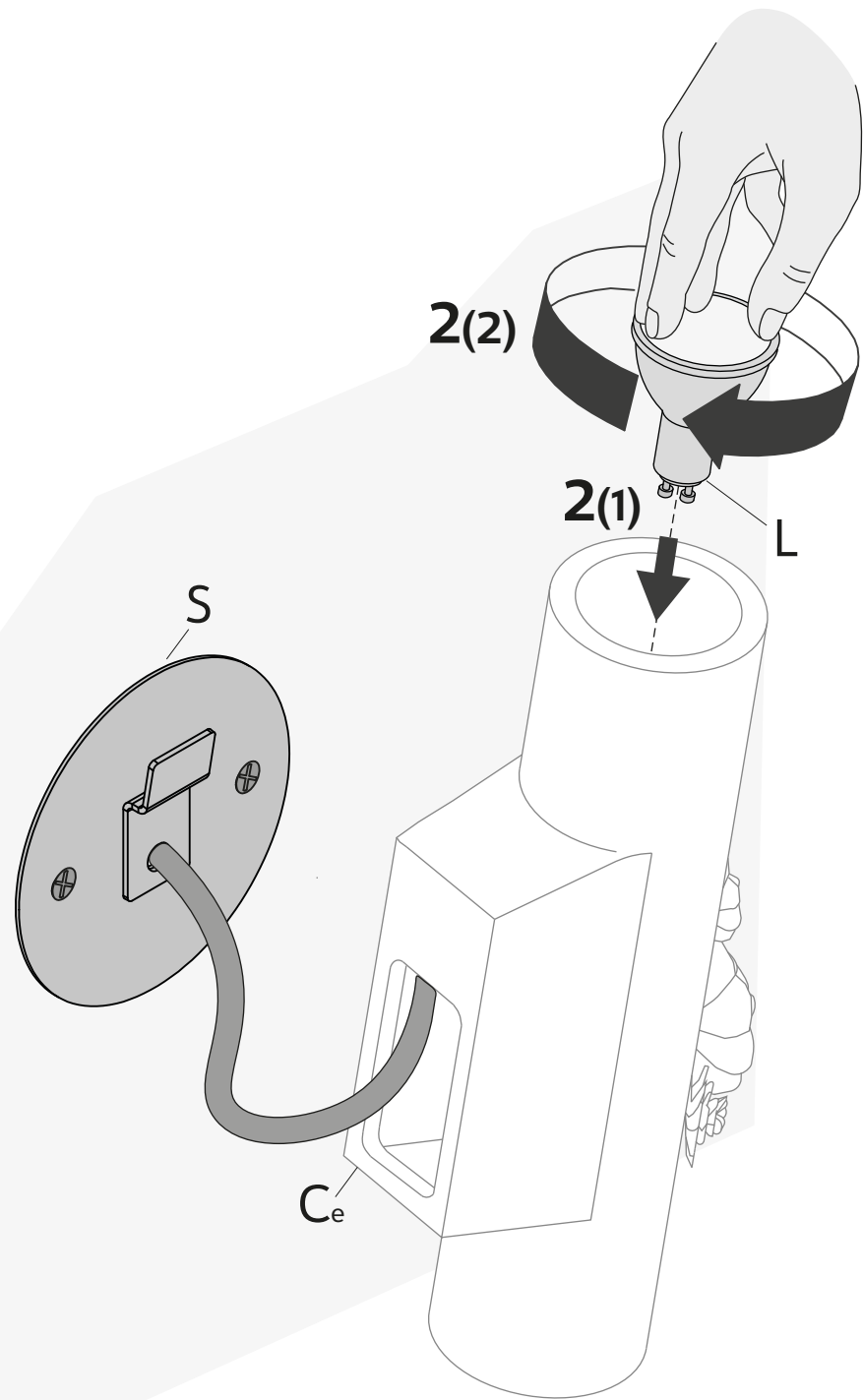

2

