

24KARATI

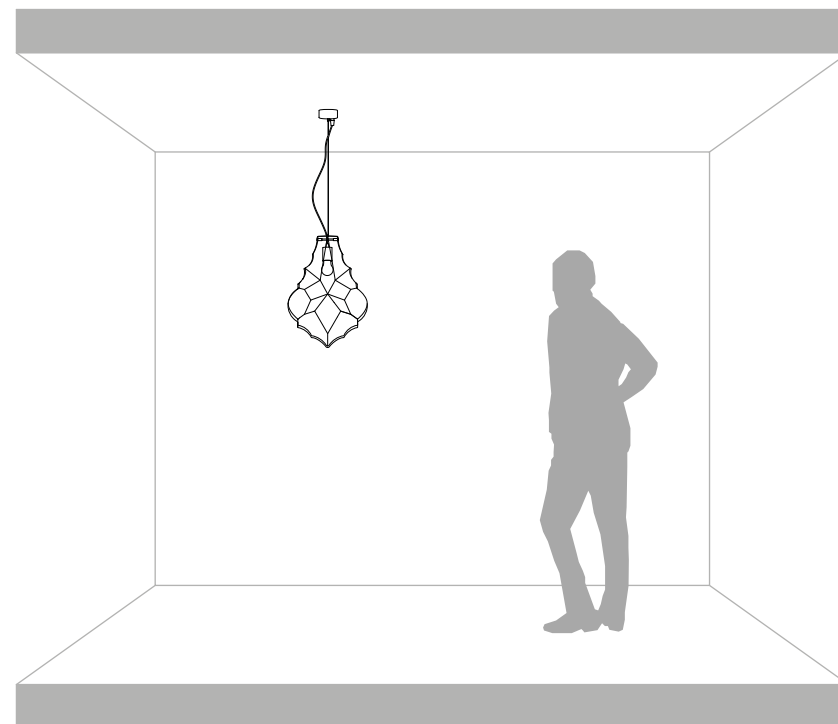

**SE104 1G V11
SE104 1F V11
SE104 1B V11**

**110 V.
max 1 x max18W LED - E26**



DRY LOCATION

IT_ Se il cavo flessibile esterno di quest'apparecchio viene danneggiato, deve essere sostituito dal costruttore o dal servizio di assistenza o da personale qualificato equivalente al fine di evitare pericoli.

-Togliere tensione prima dell'installazione o di qualsiasi manutenzione.
-Il prodotto deve essere montato da personale qualificato, rispettando le norme impianti in vigore.

 0-14	Attenzione! Apparecchio artistico, tenere lontano dalla portata dei bambini.		Attenzionel Rischio scossa elettrica. Togliere la tensione elettrica in assenza di lampadina.
--	--	---	---

EN_ If the flexi cord on the outside of this appliance becomes damaged, it must be replaced by the manufacturer or by its assistance service or a qualified service engineer, in order to avoid all hazard risks.
-Disconnect from the mains power before installing or carrying out any maintenance.
-This item must be fitted by a qualified person, compliant with current installation regulations.

 0-14	Warning! Artistic appliance. Keep out of the reach of children.		Warning! Electric shock risk. Disconnect from the mains power if no light bulb is fitted.
--	---	---	---

FR_ Si le câble souple externe de cet appareil est endommagé, il doit être remplacé par le fabricant, par son service d'assistance ou par une personne qualifiée afin d'éviter tout danger.
-Couper l'alimentation avant l'installation ou toute opération d'entretien.
-Le produit doit être installé par un personnel qualifié, en respectant les règles d'installation en vigueur.

 0-14	Attention ! Cet appareil n'est pas un jeu, tenir hors de la portée des enfants.		Attention ! Risque de choc électrique. Couper l'alimentation électrique en l'absence d'ampoule.
--	---	---	---

DE_ Wenn das äußere Kabel dieses Gerätes beschädigt wird, muss es durch den Hersteller, den Kundendienst oder ähnlich qualifizierte Personen ersetzt werden, um Gefahren zu vermeiden.
-Unterbrechen Sie die Stromversorgung vor der Installation oder Wartung.
-Das Produkt darf nur von qualifizierten Personen und unter Beachtung der geltenden Anlagenvorschriften installiert werden.

 0-14	Achtung! Kein Spielzeug! Bitte von Kindern fernhalten.		Achtung! Stromschlaggefahr. Unterbrechen Sie die Stromversorgung, falls keine Glühbirne eingeschraubt ist.
--	--	---	--

ES_ Si el cable flexible externo de este aparato se daña debe ser sustituido por el fabricante o el servicio de asistencia o personal cualificado equivalente para evitar peligros.
-Quitar tensión antes de proceder con la instalación o cualquier trabajo de mantenimiento.
-El producto debe ser montado por personal cualificado de conformidad con las normas vigentes para instalaciones.

 0-14	¡Atención! Aparato artístico, mantener alejado del alcance de los niños.		¡Atención! Riesgo de choque eléctrico. Desconectar la tensión eléctrica en ausencia de bombilla.
--	--	---	--

PT_ Se o cabo flexível externo deste aparelho for danificado, deve ser substituído pelo fabricante ou pelo serviço de assistência ou por pessoal qualificado equivalente, para evitar perigos.
-Desligue a tensão antes da instalação ou qualquer operação de manutenção.
-O produto deve ser montado por pessoal qualificado, respeitando as normas dos sistemas em vigor.

 0-14	Atenção! Aparelho artístico, manter longe do alcance das crianças.		Atenção! Risco de choque elétrico. Desligar a tensão elétrica na ausência de lâmpada.
--	--	---	---

NL_ Om gevaar te vermijden moet de externe flexibele kabel van dit apparaat, indien beschadigd, door de fabrikant, zijn technische dienst of equivalent bevoegd personeel vervangen worden.
-Voor elke installatie of onderhoudswerkzaamheid de spanning afsluiten.
-Het product moet door bevoegd personeel gemonteerd worden met inachtneming van de geldende normen.

 0-14	Aandacht! Art apparaat, uit de buurt van kinderen houden.		Aandacht! Gevaar voor elektrische schokken. Als geen lamp aanwezig is de stroom afsluiten.
--	---	---	--

SV_ Om apparatens sladd skadas ska den för att förhindra risker bytas ut av tillverkaren, kundservice eller likvärdig kvalificerad personal.
-Koppla alltid bort spänningen innan installation eller underhållsarbete.
-Produkten ska monteras av kvalificerad personal som ska följa gällande anläggningsföreskrifter.

 0-14	Observerat Detta är ett konstföremål, inte en leksak, och ska förvaras utom räckhåll för barn.		Observerat Risk för elstöt. Koppla bort den elektriska spänningen när det saknas utom räckhåll för barn.
--	--	---	--

NO_ Hvis den bøyelige ytre ledningen ved dette apparatet skades, må den skiftes ut av produsenten eller servicetjenesten eller av tilsvarende kvalifisert fagfolk for å kunne unngå farer.
-Koble fra spenningen før installasjon eller ethvert vedlikeholdsinngrep.

-Produktet må være montert av kvalifisert fagfolk, mens de gjeldene lovforskriftene overholdes.

 0-14	Advarsel! Kunstnerisk apparat, må holdes utenfor barns rekkevidde.		Advarsel! Fare for elektrisk støt. Koble fra den elektriske spenningen hvis lyspæren mangler.
--	--	--	---



FI_ Jos tämän laitteen ulkopuolinen johto vahingoittuu, vaarojen välttämiseksi se on annettava vaihdettavaksi valmistajalle tai huoltopalvelulle tai vastaava ammattitaidon omaavalle henkilökunnalle.
-Poista jännitte ennen asennusta tai ennen minkä tahansa huoltotoimenpiteen suorittamista.
-Tuote on asennettava ammattitaitoisen henkilökunnan toimesta voimassa olevia määräyksiä noudattaen.

 0-14	Varoitus! Taidelaite, pidä lasten ulottumattomissa.		Varoitus! Sähköiskuvaara. Poista sähköjännitte, kun laitteessa ei ole lampua.
---	---	---	---



PL_ Jeżeli przewód giętki na zewnątrz urządzenia zostanie uszkodzony, ze względu bezpieczeństwa musi zostać wymieniony przez producenta, serwis techniczny lub osobę o równorzędnych kwalifikacjach.
-Przed przystąpieniem do instalacji lub jakiegokolwiek czynności konserwacyjnej odłączyć napięcie.
-Produkt musi zostać zamontowany przez wykwalifikowany personel zgodnie z obowiązującymi przepisami dotyczącymi instalacji.

 0-14	Uwaga! Wyrób artystyczny, przechowywać poza zasięgiem dzieci.		Uwaga! Niebezpieczeństwo porażenia prądem. W przypadku braku żarówki odłączyć od napięcia elektrycznego.
---	---	---	--

CS_ V případě poškození externího kabelu tohoto svítidla musíte zajistit jeho výměnu prostřednictvím výrobce, technického servisu nebo kvalifikovaného technika, aby nedošlo k žádným nebezpečným situacím.
-Před instalací a údržbou odpojte od přívodu elektrického proudu.
-Výrobek musí namontovat kvalifikovaný technik za dohledání platných předpisů.

 0-14	Pozor! Umělecké svítidlo. Uchovávejte mimo dosah dětí.		Pozor! Nebezpečí zásahu elektrickým proudem. Po sejmutí žárovky odpojte svítidlo od přívodu elektrického proudu.
---	--	---	--

SK_ Ak sa poškodí externý flexibilný kábel tohto svietidla, výrobca alebo asistenčná služba alebo kvalifikovaný pracovník musí vykonať jeho výmenu za rovnaký, aby sa predišlo rizikám.
-Pred vykonaním inštalácie alebo akejkolvek údržby odpojte napätie.
-Výrobok musí namontovať kvalifikovaný pracovník s dodržaním, platných noriem.

 0-14	Upozornenie! Melekké svietidlo, držte ho z dosahu detí.		Upozornenie! Riziko zasiahnutia elektrickým prúdom. Ak sa v prístroji nenachádza žiarovka, pripojte elektrický prúd.
---	---	---	--

SL_ Če se zunanjí prožni kabel naprave poškoduje, ga mora zamenjati proizvajalec ali serviser ali enakovredno usposobljeno osebe in tako preprečiti nevarnost.
-Pred namestitvijo ali kakršnim koli vzdrževanjem izklopite napajanje.
-Proizvod mora namestiti strokovno usposobljena oseba ob upoštevanju veljavnih predpisov za namestitve.

BG_ Ако външният гъвкав кабел на това осветлително тяло бъде повреден, той трябва да се подмени от производителя, от центъра за обслужване на клиенти или от друг квалифициран персонал, за да се избегнат евентуални рискове.
-Изключете захранването преди да извършвате операции по монтаж или поддръжка.
-Продуктът трябва да се монтира от квалифициран персонал при съзвание на съответните действащи правила и разпоредби.

 0-14	Внимание! Декоративно осветително тяло. Да се пази далеч от достъп на деца.		Внимание! Риск от токов удар. Изключете захранването при липса на електрическа крушка.
---	---	---	--

RO_ În situația în care cablul flexibil exterior al acestui aparat este deteriorat, este necesar să fie înlocuit de producător sau de serviciul de asistență ori de de personal calificat echivalent, pentru a preveni aparierea pericolore.
-Întrerupeți alimentarea cu tensiune mai înainte de instalare sau de orice operațiune de întreținere.
-Produsul trebuie să fie montat de personal calificat, conform standardelor în vigoare privind instalațiile.

 0-14	Atenție! Aparat artistic, nu lăsați la îndemână copiilor.		Atenție! Risc de electrocutare. Întrerupeți alimentarea cu tensiune electrică în lipsa becului.
---	---	---	---

HR_ Ako se vanjski savitljivi kabel ovog uređaja ošteti, proizvođač ili servisna služba ili odgovarajuće osposobljeno osoblje moraju ga zamijeniti kako se ne biste izlagali mogućim opasnostima.
-Isključite napajanje prije postavljanja ili izvođenja bilo kojeg postupka održavanja.
-Postupak postavljanja treba obaviti osposobljeno osoblje i pritom se pridržavati važećih pripadajućih pravila.

 0-14	Pažnja! Budući da je riječ o zanimljivom uređaju, držite ga izvan doseg a djece.		Pažnja! Rizik od strujnog udara. Isključite napajanje ako nema žarulje.
--	--	--	---

SQ_ Nëse kabllja fleksibël e jashtme e kësaj pajisje dëmtohet, për të shmangur rreziqet, ajo duhet të zëvendësohet nga konstruktori, shërbimi i asistencës ose nga personeli i kualifikuar ekuivalent.
-Heqim tensionin para instalimit ose para çdo lloji rimbëmbajtje.
-Produkti duhet të montohet nga një person i kualifikuar, duke respektuar normat në fuqi për impiantet.

 0-14	KUJDESI! Pajisje artistike, duhet mbajtur larg nga vendet që arrihen nga fëmijët.		KUJDESI! Rrezik goditje elektrike. Kur lambla nuk është e montuar, duhet të shkëputim furnizimin me energji elektrike.
---	---	---	--

SR_ Ako se spoljni kabl ovog uređaja ošteti, isti mora biti zamenjen od strane proizvođača, ovlašćenog servisa ili kvalifikovanog osoblja kako bi se izbegle moguće opasnosti.
-Pre ugradnje ili bilo kakvog održavanja, isključiti struju.
-Proizvod mora biti montiran od strane kvalifikovanog osoblja, u skladu sa važećim propisima.

 0-14	Pažnja! Umetnički komad. Držati ga dalje od dohvata dece.		Pažnja! Rizik od strujnog udara. Isključiti iz struje kada u uređaju nema sijalice.
---	---	---	---

TR_ Bu cihazın dışı esnek kablosunun hasar görmesi halinde, tehnikelerinin önlenmesi amacıyla, işbu kablo imalatçı veya teknik servis ya da eşdeğer kalifiye personel tarafından değiştirilmelidir.
-Kurulmadan önce herhangi bir bakım işleminden önce gerilimi kesiniz.
-Ürün, yürürlükteki yönetmeliklere uygun olarak, kalifiye personel tarafından monte edilmelidir.

 0-14	Dikkat! Dekoratif cihaz, çocukların ulaşamayacağı yerlerde saklayınız.		Dikkat! Elektrik çarpması riski. Ampul yoksa elektrik gerilimini kesiniz.
---	--	---	---

SH_ Ako je oštećen vanjski savitljivi kabl ovog uređaja mora biti zamijenjen od strane proizvođača ili odgovarajućeg servisnog centra ili kvalifikovanog osoblja kako bi se izbjegla opasnost.
-Isključite napajanje prije instalacije ili bilo kakvog održavanja.
-Proizvod mora biti montiran od strane kvalifikovanog osoblja, u skladu sa važećim propisima.

 0-14	Upozorenje! Umjetnički uređaj, držati podalje od djece.		Upozorenje! Rizik od strujnog udara. Isključite napajanje strujom u odsustvu sijalice.
---	---	---	--

EL_ Εάν το εξωτερικό εύκαμπτο καλώδιο αυτής της συσκευής έχει υποστεί ζημιά, θα πρέπει να αντικατασταθεί από τον κατασκευαστή ή το σέρβις ή από προσωπικό προωθητικό, προκειμένου να αποφευχθεί τυχόν κίνδυνος.
-Αφαιρέστε την τάση πριν από την εγκατάσταση ή από οποιαδήποτε συντήρηση.
-Το προϊόν πρέπει να εγκατασταθεί από εξειδικευμένο προσωπικό, σύμφωνα με τους κανονισμούς εγκατάστασης.

 0-14	Προσοχή! Καλλιτεχνική συσκευή, να φυλάσσεται μακριά από παιδιά.		Προσοχή! Επείγει κίνδυνος ηλεκτροπληξίας. Αποσυνδέστε την παροχή ηλεκτρικού ρεύματος σε περίπτωση απουσίας του λαμπτήρα.
---	---	---	--

RU_ Если у данного прибора окажется поврежденным наружный шнур, то, во избежание риска, обратитесь за его заменой к изготовителю, либо в сервисный центр, либо к обладающему необходимой квалификацией мастеру.
-Перед осуществлением монтажа и любого технического обслуживания отключайте напряжение.
-Установка прибора должна осуществляться квалифицированными мастерами в соответствии с действующими правилами электромонтажа.

 0-14	Внимание! Данное художественное изделие необходимо хранить в недоступном для детей месте.		Внимание! Риск поражения электрическим током. При отстутствии лампочки отключайте электронапряжение.
---	---	---	--

UK_ Якщо зовнішній гнучкий кабель чи шнур світильника пошкоджено, його має замінити виробник чи представник служби обслуговування або особа з відповідною кваліфікацією, щоб уникнути небезпек.
-Перш ніж встановлювати виріб або проводити будь-які дії з технічного обслуговування, слід від'єднати світильник від джерела живлення.
-Виріб має встановлюватися кваліфікованим спеціалістом відповідно до діючих стандартів.



 0-14	Увага! Художній виріб. Тримати подаль від дітей.		Увага! Небезпека ураження електричним струмом. Від'єднати світильник від джерела живлення якщо електрична лампочка відсутня.
---	--	---	--

LV_ Ja šai ierīci ir bojāts ārējais lokālais vads, tā nomaiņa jāuztiek ražotājam, servisa centra speciālistam vai darbiniekam ar līdzīgu kvalifikāciju, lai izvairītos no briesmām.
-Pirms uzstādīšanas vai jebkādu apkopes darbu veikšanas atslēdziet strāvas padevi.
-Produkta uzstādīšana jāuztiek kvalificētam speciālistam, kuram jāievēro spēkā esošie noteikumi elektroinstalācijas darbu jomā.

 0-14	Uzmanību! Mākslas izstrādājums, turēt bērniem neaizsargājamā vietā.		Uzmanību! Elektriskās strāvas trieciena risks. Atslēdziet strāvas padevi, ja nav uzstādīta spuldze.
---	---	---	---

LT_ Jei išorinis lankstus šio prietaiso laidas yra pažeistas, ji turi pakeisti gamintojas, techninės priežiūros paslaugų teikėjai arba atitinkami kvalifikuoti darbuotojai, kad būtų išvengta pavojų.

-Prieš įrengimą ar bet kokią techninę priežiūrą išjunkite srovės šaltinį.
-Gaminį turi įrengti kvalifikuoti darbuotojai, laikydamiesi galiojančių įrenginių įrengimo taisyklių.
-Atsargiai! Tai meninis įrenginys, saugoti nuo vaikų.



 0-14	Atsargiai! Tai meninis įrenginys, saugoti nuo vaikų.		Atsargiai! Elektros smūgio pavojus. Nesant lemputės, išjunkite srovės šaltinį.
---	--	---	--

ET_ Kui seadme väline painduv juhe saab kahjustada, peab selle ohtude vältimiseks välja vahetama kas toote valmistaja, teenusduskesuse või samasuguse kvalifikatsiooniga töötaja.
-Paigaldamiseks või enne mis tahes hoolduse tegemist eemaldage seade elektrivõrgust.
-Toote tohib paigaldada ainult asjakohaste kutseoskustega töötaja, kes järgib seadmete tehnikaid ettekirjutusi.



ZH_ 若本设备的外接柔性电线受损，必须由制造商、售后服务方或具有相同资质的专业人员更换，以避免发生事故。
安装或维修前请切断电源。
本设备需由专业人员遵照相关规定进行安装。

 0-14	请注意！小心触电。无灯时请务必切断电源。		Tähelepanu! Elektrilöögi oht. Kui elektripiiri ei ole paigaldatud, siis ärge seadet elektrivõrku ühendage.
---	----------------------	---	--

KO_ 본 기기의 외부 전선 케이블이 손상된 경우, 위험을 방지하기 위해 제조사 또는 서비스 센터 또는 이의 동등한 자격을 갖춘 전문가에 의해 교체해야 합니다.
어떠한 경우라도 기기를 보수하거나 설치 시에는 전원을 차단해야 합니다.
이 제품을 준비가 된 자격을 갖춘 전문가에 의해 설치 규정을 준수하여 설치되어야 합니다.

 0-14	주의! 디자인 기기와 어린이의 주의의 팔기 위험이 있습니다. 기기에 전구가 설치되지 않은 상태에서 전원을 차단하십시오.		주의! 감전 위험이 있습니다. 기기에 전구가 설치되지 않은 상태에서 전원을 차단하십시오.
---	--	---	---

JA_ 外部ケーブルが損傷した場合の交換は、危険を避けるため、生産者がアフターサービス、または同等の有資格者が行ってください。
取り替えを含むあらゆるメンテナンスをする際は、必ず電源をお切りください。
組み立てる際は取扱説明書に従い、有資格者が行ってください。

 0-14	注意！デザイン器具ですので、お子様の手の届かぬところでご使用ください。		注意！感電の恐れがあります。電球を取り外しの際は電源をお切りください。
---	-------------------------------------	---	-------------------------------------

HI_ खतरे से बचने के लिए उपकरण का क्षतिग्रस्त बाहरी लचीला तार निर्माता या विक्री के उपरान्त सर्विस कर्मचारियों द्वारा ही बदला जाना चाहिए। तार बदलने के पहले या रखरखाव के किसी भी कार्य से पहले बिजली बंद कर दें। प्रोडक्ट योग्य कर्मचारियों द्वारा ही नियमानुसार तरीकेसे इन्स्टॉल किया जाना चाहिए ।



 0-14	सावधान! उपकरण कलात्मक है अतः बच्चों से दूर रखें।		सावधान! बिजली के झटके का खतरा है। बल्ब न होने पर बिजली की आपूर्ति काट दें।
---	--	---	--

HE_ התקנת המוצר תבוצע על ידי אנשים מוסמכים בלבד, או שירות התמיכה או אנשים מוסמכים נדרשים להחליף או לשנות את חלקי המוצר.
כדי למנוע סכנה יש לנתק את אספקת החשמל לפני התקנה או תחזוקה כלשהי

HE_ התקנת המוצר תבוצע על ידי אנשים מוסמכים בלבד, התאם לתקנות הנהגות בנושא מתקנים.

 0-14	אזהרה! סכנת התחשמלות. אזהרה! מכשיר בהיעדר נורה, יש לנתק את אספקת החשמל.		אזהרה! סכנת התחשמלות. אזהרה! מכשיר בהיעדר נורה, יש לנתק את אספקת החשמל.
---	---	---	---

AR_ إذا تعرض السلك الخارجي المرمن للجهاز إلى التلف فيجب استبداله من قبل الشركة المصنعة أو مركز خدمة المساء عدة أو من قبل عمال مؤهلون من نوي الخيرية، وذلك تجنباً للتعرض إلى المخاطر. يجب فصل المنتج عن التيار الكهربائي عند التركيب وعند القيام بآية عملية من عمليات الصيانة.
يجب عدم عمال مؤهلون بترتيب المنتج ويجب أن يتم هذا بالاستناد إلى التوجيهات السارية الخاصة بالأجهزة.

 0-14	تنبيه! هذا الجهاز هو قطعة فنية يجب فصل الجهاز عن التيار الكهربائي عند عدم وجود المصباح الكهربائي.		تنبيه! هذا الجهاز هو قطعة فنية يجب فصل الجهاز عن التيار الكهربائي عند عدم وجود المصباح الكهربائي.
---	---	---	---

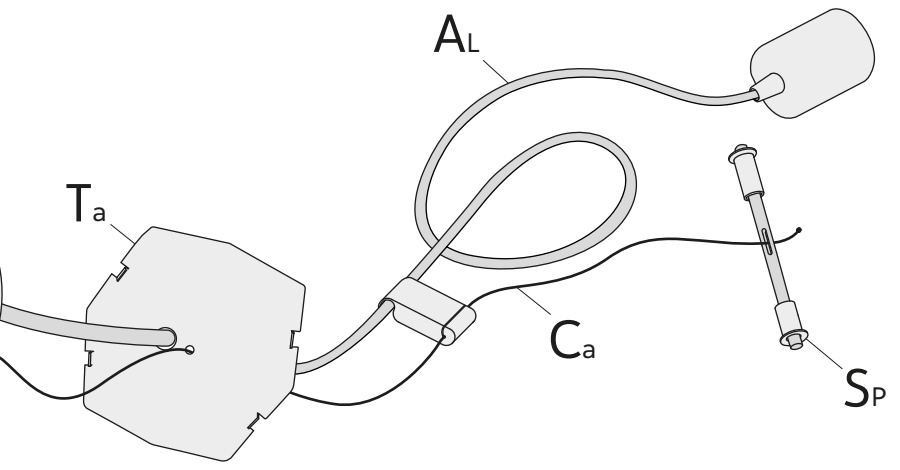
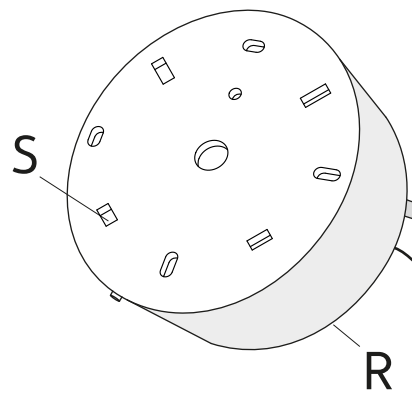
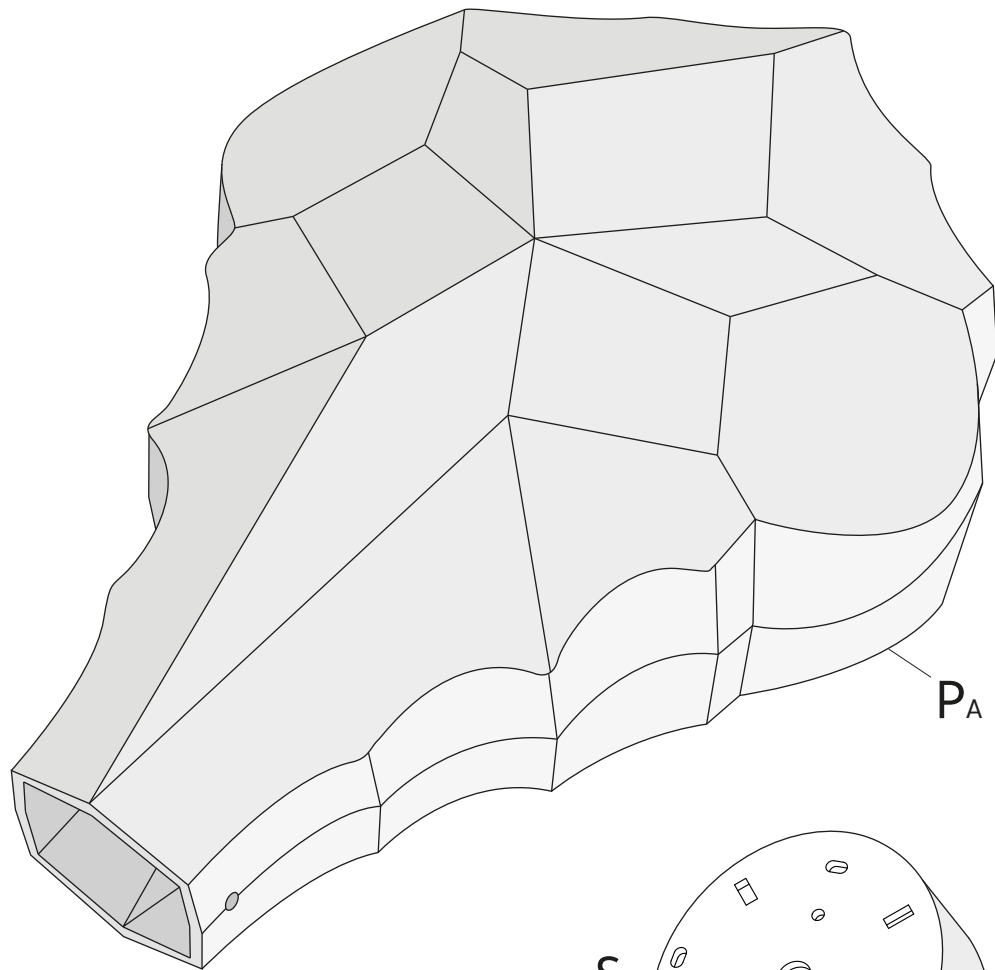

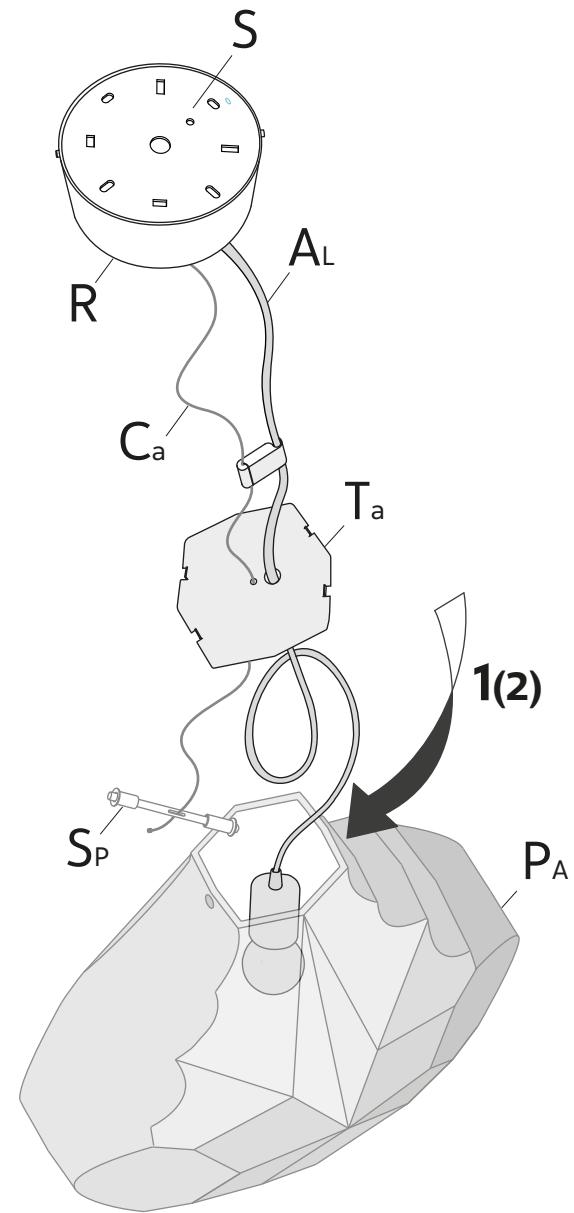
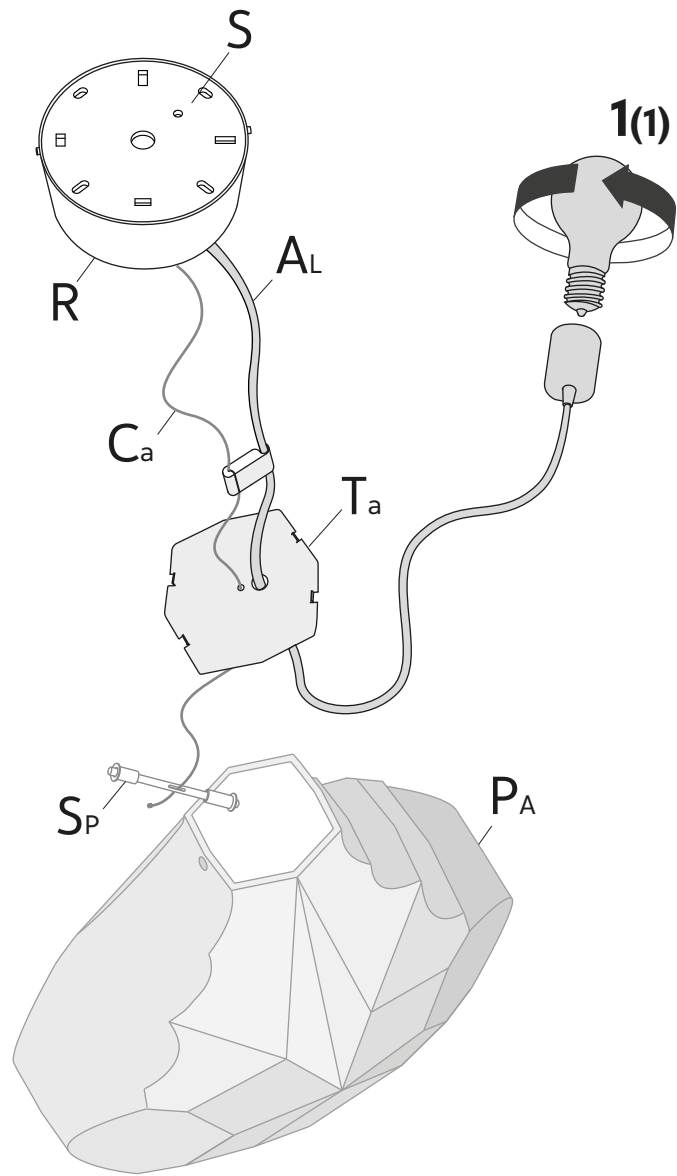
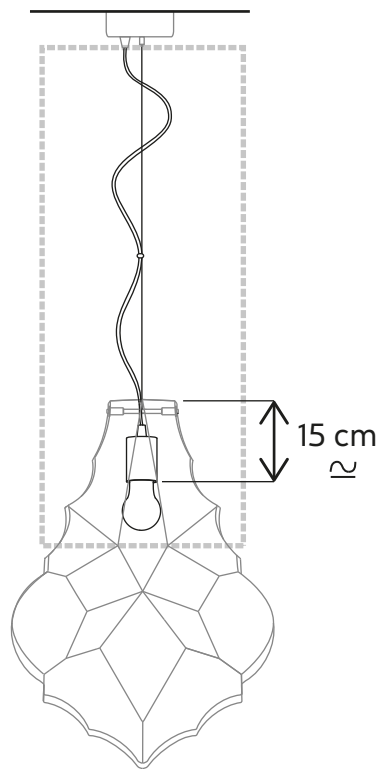

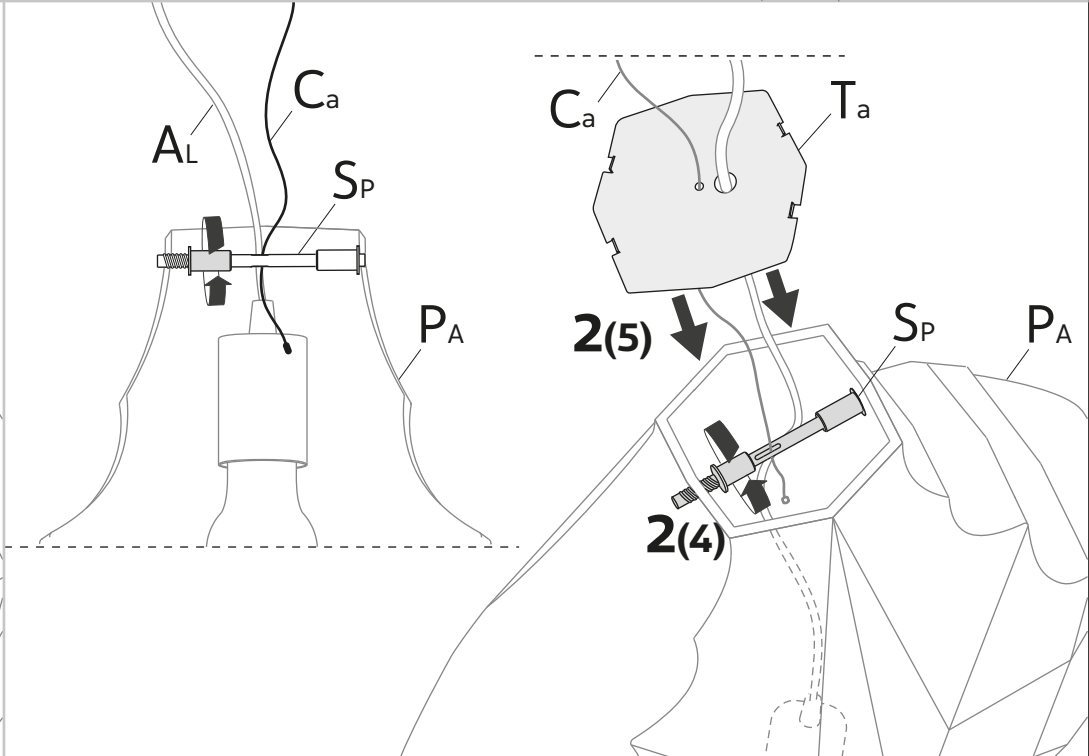
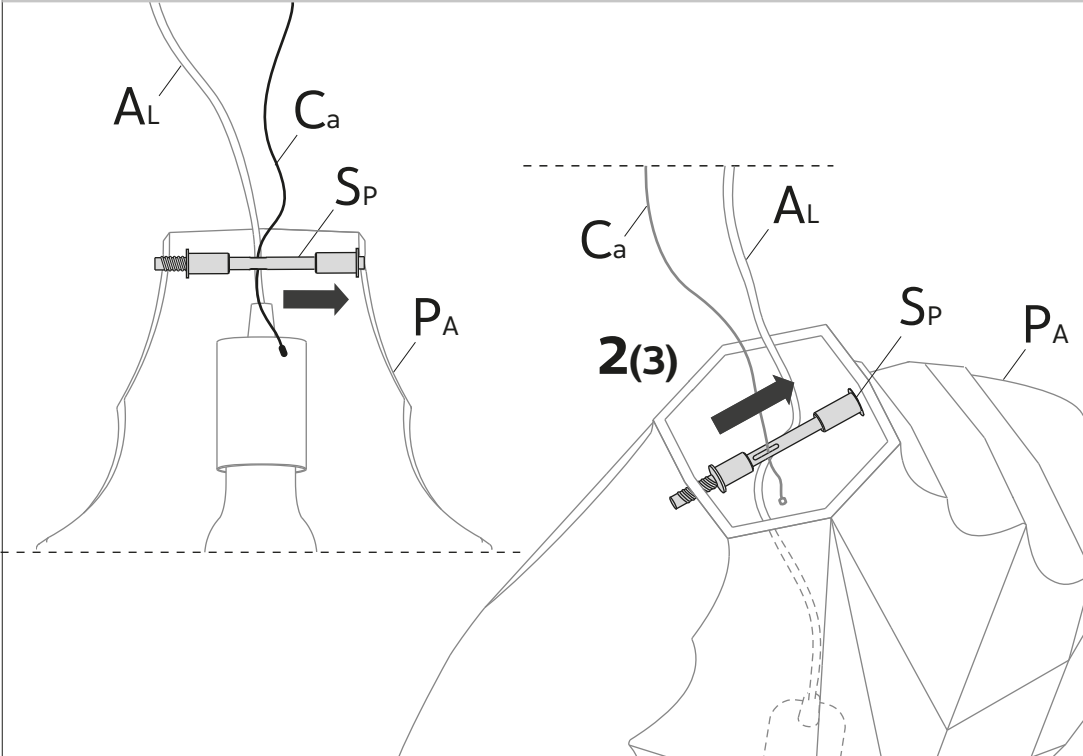
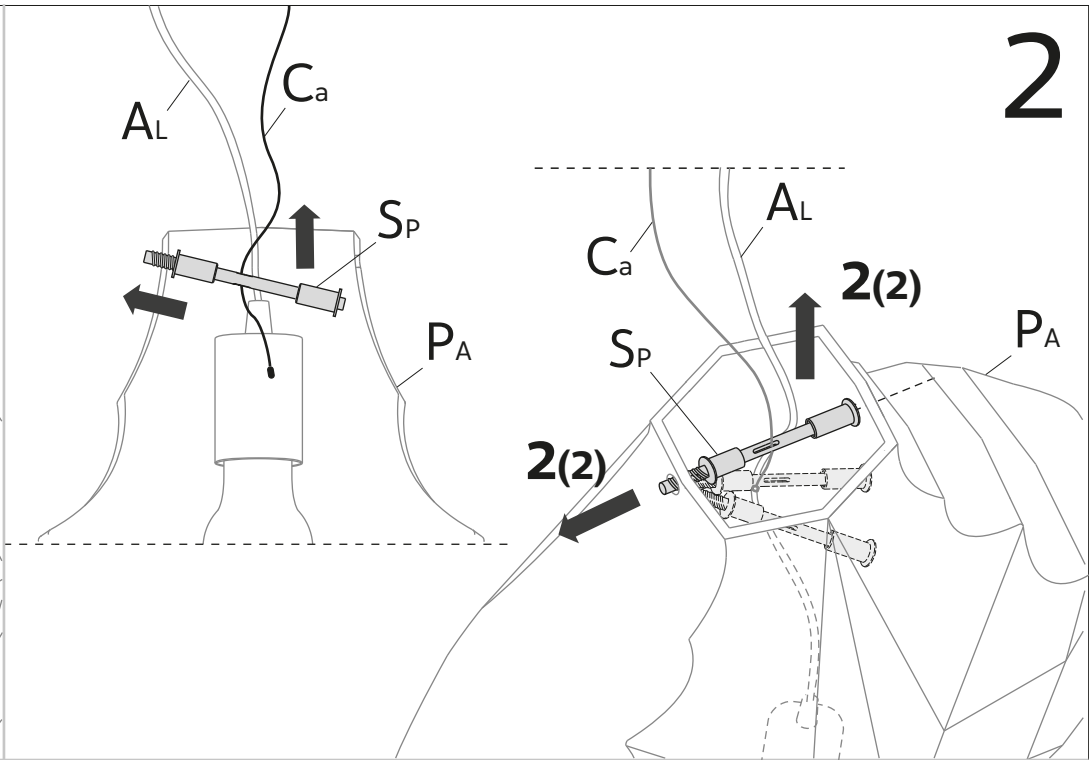
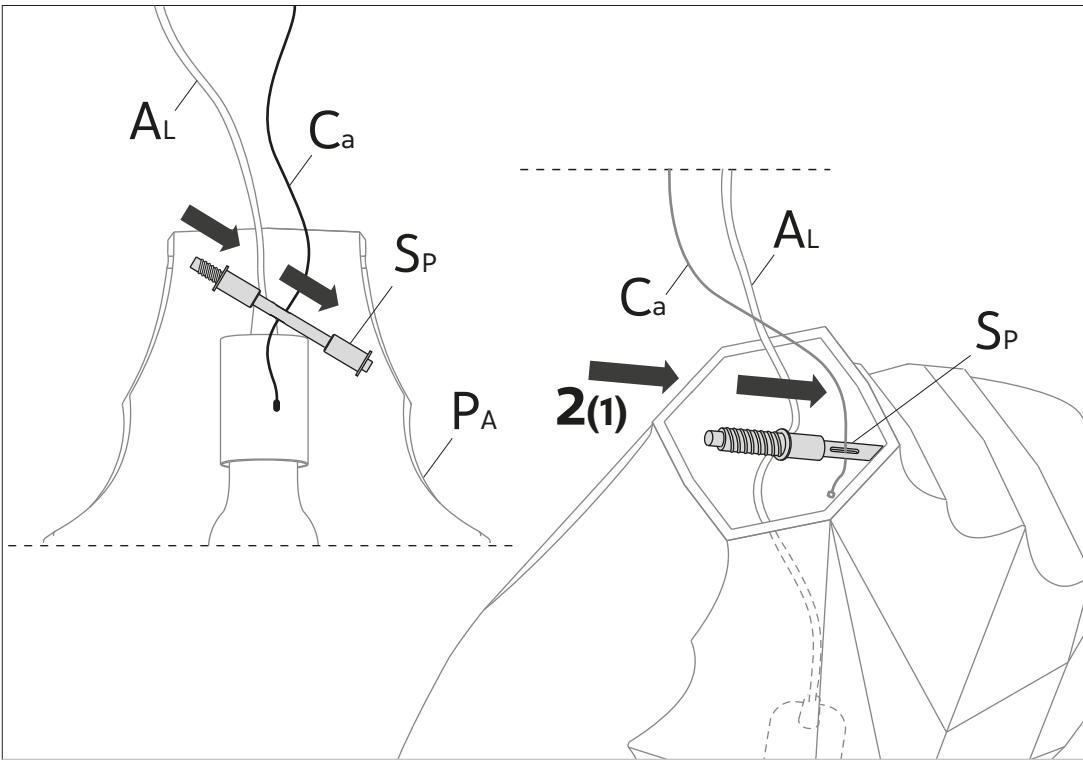

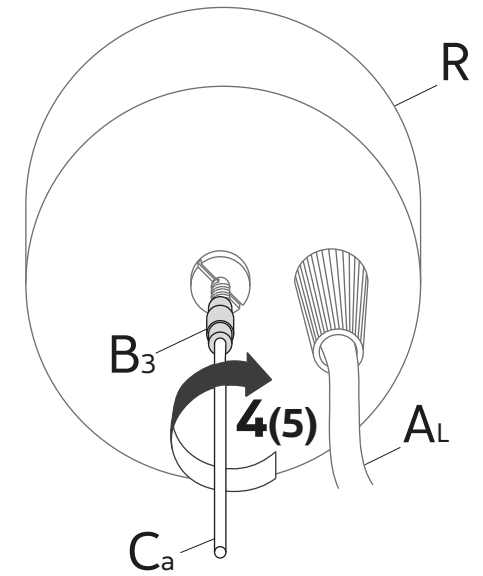
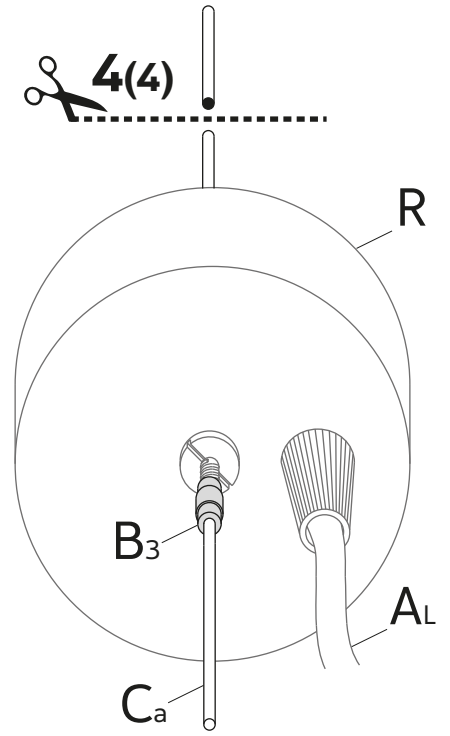
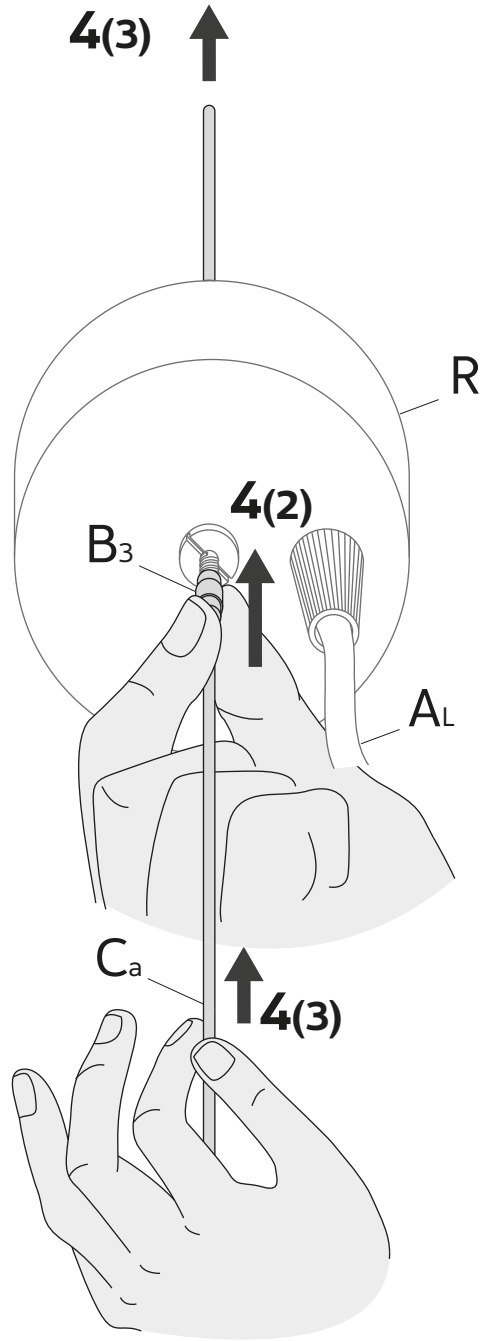
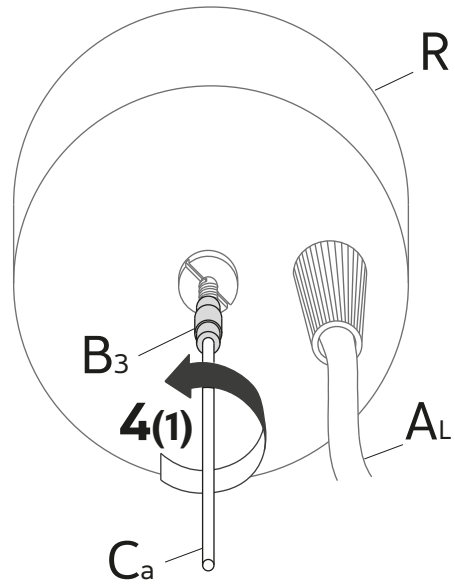
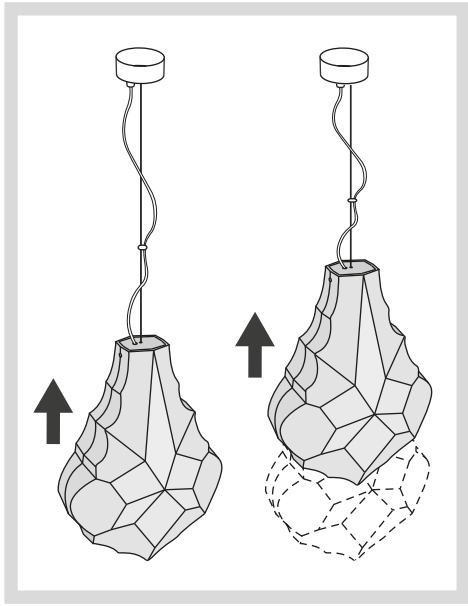

Junction Box

